

# DENTAL

INSTRUMENTS CATALOGUE



SHAMEEL  
INSTRUMENTS

Manufacturers & Exporters of Dental Instruments.



## Dear Valued Buyers

We feel immense pleasure to present our latest catalogue in which we have featured a most comprehensive range of all types of quality Surgical & Dental instruments required for day to day use for Hospital. We will be pleased to quote you a competitive Price and Delivery time.

All instruments are manufactured according to the recognized standard patterns currently in use in Hospital throughout the world and are being produced under restrict control of experts to avoid any flaw and to refrain any complaint at any stage.

A group of very vast experienced persons in manufacturing handling our quality Control System.

Any instruments proven defective in workmanship or material will be replaced with out charges.

We express our thanks to all our customers for the confidence they have placed us in the past. We further assure them that we will continue our best efforts to gain their confidence in the future.

We are always at your service.

Chief Executive

**SHAMEEL**  
**INSTRUMENTS**



**01**

**EXTRACTING FORCEPS**

**Page # 01 - 28**

**02**

**ROOT ELEVATORS**

**Page # 29 - 48**

**03**

**DIAGNOSTIC, PROBES, SCALERS, FILLING  
& LABORATORY INSTRUMENTS**

**Page # 49 - 98**

**04**

**MAXILLOFACIAL SURGERY  
INSTRUMENTS**

**Page # 99 - 124**

**05**

**ORTHODONTIC INSTRUMENTS  
& PLIERS**

**Page # 125 - 144**

**06**

**DENTAL IMPLANT INSTRUMENTS  
& Impression Tray**

**Page # 145 - 182**

**07**

**HOLLOWARE**

**Page # 183 - 191**



Handle Selection For Extracting Forceps

Dear Valued Buyers if any Universal Fig. No. of Extracting Forceps not Found in our Catalogue you Can Refer the Fig. No. From These Diagram.

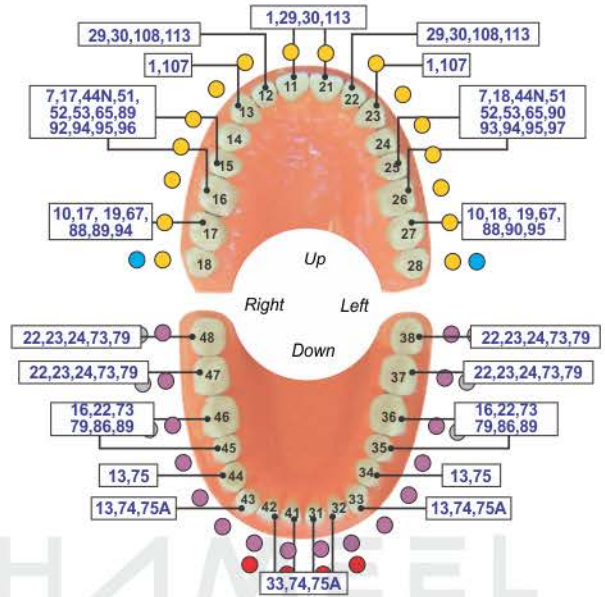
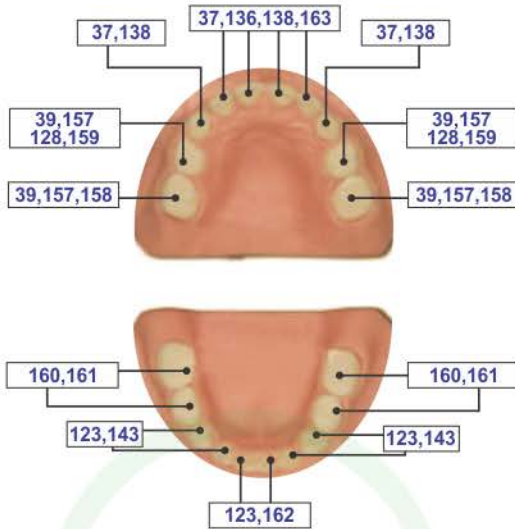

Dear Valued Buyers these are our Handle Styles







# EXTRACTING FORCEPS (English Pattern)

- Щипцы экстракционные (английская форма)
- Daviers (Forme Anglaise)
- Zahnzangen (Englische Form)
- Щипці екстракційні (англійська форма)
- Forceps de Extracción (Forme Inglesa)
- استخراج الملقط (نمط اللغة الإنجليزية)

Function: To remove teeth from bony socket



**DE-001**  
Fig. 1  
Upper Centrals  
and Canines



**DE-002**  
Fig. 2  
Upper Laterals  
and Canines



**DE-003**  
Fig. 4  
Lower Incisors  
and Canines



**DE-004**  
Fig. 7  
Upper Premolars



**DE-005**  
Fig. 8  
Lower Premolars



**DE-006**  
Fig. 13  
Lower Premolars



**DE-007**  
Fig. 17  
Upper Molars,  
Right



**DE-008**  
Fig. 18  
Upper Molars, Left



**DE-009**  
Fig. 21  
Lower Molar



**DE-010**  
Fig. 22  
Lower Molar



Straight extracting forceps for upper incisors and canines



Straight extracting forceps for upper incisors and canines



Straight extracting forceps for upper incisors and canines

## EXTRACTING FORCEPS (English Pattern)

- Щипцы экстракционные (английская форма)
- Щипці екстракційні (англійська форма)
- Forceps de Extracción (Forme Inglesa)
- استخراج الملقط (نمط اللغة الإنجليزية)
- Daviers (Forme Anglaise)
- Forcets de Extracción (Forme Inglesa)
- Zahnzangen (Englische Form)

Function: To remove teeth from bony socket



DE-011  
# 18A  
upper molars



DE-012  
# 19  
upper third molars



DE-013  
# 20  
lower third molar



DE-014  
# 24  
lower molar, right



DE-015  
# 29  
upper roots



DE-016  
# 30  
Upper Roots



DE-017  
# 33  
lower roots



DE-018  
# 33A  
Lower Roots



DE-019  
# 33M  
Lower roots  
with long beak



DE-020  
# 46L



DE-021  
# 51  
Upper Roots



DE-022  
# 51A  
Upper Roots



Straight extracting forceps for upper incisors and canines



Straight extracting forceps for upper incisors and canines



Straight extracting forceps for upper incisors and canines





# EXTRACTING FORCEPS (English Pattern)

- Щипцы экстракционные (английская форма)
- Щипці екстракційні (англійська форма)
- Daviers (Forme Anglaise)
- Forceps de Extracción (Forme Inglesa)
- Zahnzangen (Englische Form)
- استخراج الملقط (تمط اللغة الإنجليزية)

Function: To remove teeth from bony socket

## WISDOM EXTRACTING FORCEPS



**DE-023 Routerier (# 22 1/2 L)**  
lower molars and wisdoms, left



**DE-024 Routerier (# 22 1/2 R)**  
lower molars and wisdoms, right



**DE-025 Routerier (# 33 1/2 L)**  
lower molar and wisdom roots, left



**DE-026 Routerier (# 33 1/2 R)**  
lower molar and wisdom roots, right



*Routerier extracting forceps for lower molars and third molars, right*



**DE-027 Fig. 186L**  
lower molars



**DE-028 Fig. 186R**  
lower molars



**DE-029 # 51AL**



**DE-030 # 67**  
Upper Third Molars



**DE-031 # 67A**  
Upper Third Molars



**DE-032 # 79**  
Lower Third Molars



*Angled extracting forceps for upper roots*

# EXTRACTING FORCEPS (English Pattern)



- Щипцы экстракционные (английская форма)
- Daviers (Forme Anglaise)
- Zahnzangen (Englische Form)
- Щипці екстракційні (англійська форма)
- Forceps de Extracción (Forme Inglesa)
- استخراج الملقط (نمط اللغة الإنجليزية)



**DE-033**  
**# 73**  
Lower Molars



**DE-034**  
**# 73 A**  
lower molars



**DE-035**  
**# 73 S**



**DE-036**  
**# 74**  
Lower Roots



**DE-037**  
**# 74N**  
Lower Roots



**DE-038**  
**# 75**  
Lower Premolars



**DE-039**  
**# 86A**  
Lower Molars



**DE-040**  
**# 86B**  
lower molars



**DE-041**  
**# 86C**  
lower molars



**DE-042**  
**# 87**  
Lower Molars



**DE-043**  
**# 89**  
Upper Molars,  
Right



**DE-044**  
**# 90**  
Upper Molars,  
Left



Straight extracting forceps for upper incisors and canines



Straight extracting forceps for upper incisors and canines



Straight extracting forceps for upper incisors and canines





# EXTRACTING FORCEPS (English Pattern)

- Щипцы экстракционные (английская форма)
- Daviers (Forme Anglaise)
- Zahnzangen (Englische Form)
- Щипці екстракційні (англійська форма)
- Forceps de Extracción (Forme Inglesa)
- استخراج الملقط (نمط اللغة الإنجليزية)

## DE-TRAUMATIC EXTRACTION

Improved tapered beaks for complete root contact. Cross serrations. Deep Gripe Extracting Forceps



- No Fracture
- No Tissue Damage
- Extraction With Easy



Thin Tip

**DE-045**  
# 34  
Upper incisors and  
premolars  
deep-gripping



Wide Tip

**DE-046**  
# 34A  
Upper centrals / cains  
deep-gripping



Thin Tip

**DE-047**  
Fig. 35  
upper permolars  
deep-gripping



Wide Tip

**DE-048**  
# 35A  
Upper incisors and  
premolars  
deep-gripping

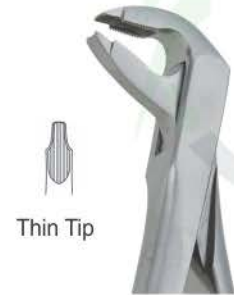

Thin Tip

**DE-049**  
# 36  
Lower premolars  
deep-gripping



Wide Tip

**DE-050**  
# 36A  
Lower premolars  
deep-gripping



**DE-051**  
# 336  
lower permolars  
deep-gripping



**DE-052**  
F-7C  
lower molar



**DE-053**  
# 9  
Apex Forceps Lower Universal  
Deep Root Pick



**DE-054**  
# 79N  
Lower third molars  
deep-gripping



**DE-055**  
# 79  
Lower Thrid Molars



### Function:

Extraction forceps are used to further loosen teeth by rotational and tilting movements and finally to extract the teeth in combination with a fulcrum.

# EXTRACTING FORCEPS (English Pattern)



- Щипцы экстракционные (английская форма)
- Daviers (Forme Anglaise)
- Zahnzangen (Englische Form)
- Щипці екстракційні (англійська форма)
- Forceps de Extracción (Forme Inglesa)
- استخراج الملقط (نمط اللغة الإنجليزية)

## DEEP ROOT PICK FORCEPS



**DE-056**  
**# 146**

Apex Forceps Lower Root  
Deep Root Pick



**DE-057**  
**# 153**

Apex Forceps Upper Root  
Deep Root Pick



**DE-058**  
**# 149**

Apex Forceps Upper Root  
Deep Root Pick



**DE-061**  
Fig. 44



**DE-060**  
Fig. 44Z



**DE-059**  
Fig. 45Z



**DE-062**  
**# 46XL**  
Apex Forceps Lower Root  
Deep Root Pick



**DE-063**  
**# 67**

Upper Third Molars



**DE-064**  
**# 67A**

Upper Third Molars



**DE-065**  
**# 67N**  
Lower third molars  
deep-gripping



**DE-066**  
**# 331**  
upper roots  
deep-gripping



forceps for upper incisors, premolars and roots







# EXTRACTING FORCEPS (English Pattern)

- Щипцы экстракционные (английская форма)
- Daviers (Forme Anglaise)
- Zahnzangen (Englische Form)

- Щипці екстракційні (англійська форма)
- Forceps de Extracción (Forme Inglesa)
- استخراج الملقط (نمط اللغة الإنجليزية)



Fig. 1  
upper  
laterals  
and canines



**DE-067**  
Set of 10 Pieces  
Fig. 1  
Fig. 7  
Fig. 13  
Fig. 17  
Fig. 18  
Fig. 22  
Fig. 51A  
Fig. 67  
Fig. 74N  
Fig. 79

Fig. 7  
upper premolars



Fig. 13  
lower premolars



Fig. 17  
upper molars, right



Fig. 18  
upper molars, left



Fig. 22  
lower roots



Fig. 51A  
upper roots



Fig. 67  
upper third molars



Fig. 74N  
lower molar



Fig. 79  
lower third molars



Extracting forceps for upper roots



# EXTRACTING FORCEPS



- Щипцы экстракционные
- Daviers
- Zahnzangen
- Щипці екстракційні
- Forceps de Extracción
- استخراج المنقط

## Pediatric Tooth Extracting Forceps Set



**DE-069**  
English Pattern Klein #51S  
Pedodontic Upper root



**DE-068**  
English Pattern Klein #137  
Pedodontic, Upper Incisors Spring handle



**DE-072**  
English Pattern Klein #5  
Pedodontic Lower Incisors.



**DE-070**  
English Pattern Klein #139  
Pedodontic Upper Premolars

### Baby Tooth Extraction Forceps



**DE-075**  
Fig. # 01 to 07  
Set of 7 Pieces



**DE-073**  
English Pattern Klein #7  
Pedodontic Lower Roots,



**DE-071**  
English Pattern Klein #3  
Pedodontic Upper Molars Universal

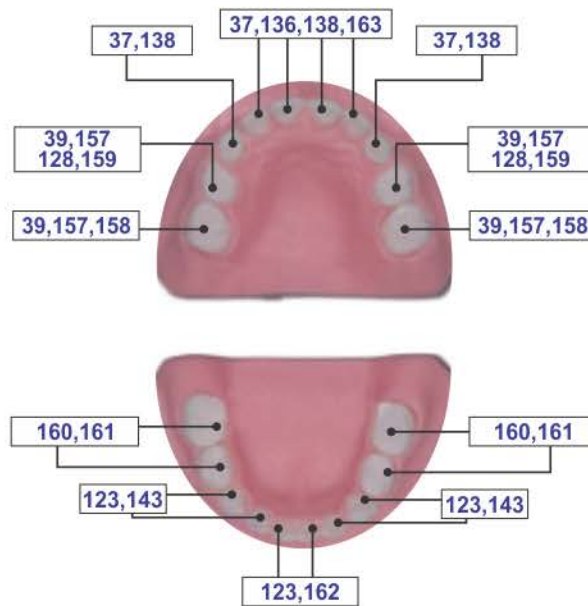

**DE-074**  
English Pattern Klein #6  
Pedodontic Lower Molars, Spring Handle





# ROOT FRAGMENT FORCEPS



Witzel  
**DE-076**  
170mm  
Upper roots, Universal



Witzel  
**DE-077**  
165mm  
Lower roots, Universal



**DE-078**  
#400(300)  
165mm  
Upper roots, Universal



**DE-079**  
#401(301)  
160mm  
Lower roots, Universal



**DE-080**  
Witzel Forceps With Gold  
Set of 3 Pcs



**DE-084**  
Witzel Forceps With Hole And Screw Pattern  
Set of 3 Pcs



**DE-088**  
Witzel Forceps With Anatomical Handle  
Set of 3 Pcs



**DE-081**  
#401(301)  
160mm  
Lower roots, Universal



**DE-085**  
#401(301)  
160mm  
Lower roots, Universal



**DE-089**  
#401(301)  
160mm  
Lower roots, Universal



**DE-082**  
#400(300)  
165mm  
Upper roots, Universal



**DE-086**  
#400(300)  
165mm  
Upper roots, Universal



**DE-090**  
#400(300)  
165mm  
Upper roots, Universal



Witzel  
**DE-083**  
165mm  
Lower roots, Universal



Witzel  
**DE-087**  
165mm  
Lower roots, Universal



Witzel  
**DE-091**  
165mm  
Lower roots, Universal

# ROOTS SPLINTER FORCEPS



- Щипцы для удаления корневых осколков
- Pincas Fragments
- Wurzelsplitterzangen
- Щипці для видалення корневих осколків
- Pinzas Para Fragmentos
- جزور منشقة الملقط



**DE-092**  
Splinter Forceps  
15.5cm



*Stieglitz Root Splinter Forceps*



**DE-093**  
Splinter Forceps  
15.5cm 45°

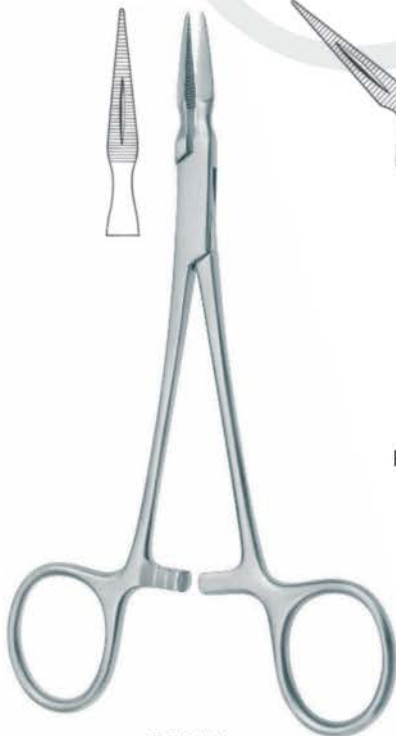

**DE-094**  
Stieglitz  
Root Fragments



**DE-095**  
Stieglitz  
Root Fragments



**DE-096**  
Stieglitz Splinter Forceps  
140mm 90°



**DE-097**  
Stieglitz Splinter Forceps  
140mm Straight





# ROOT FRAGMENT FORCEPS

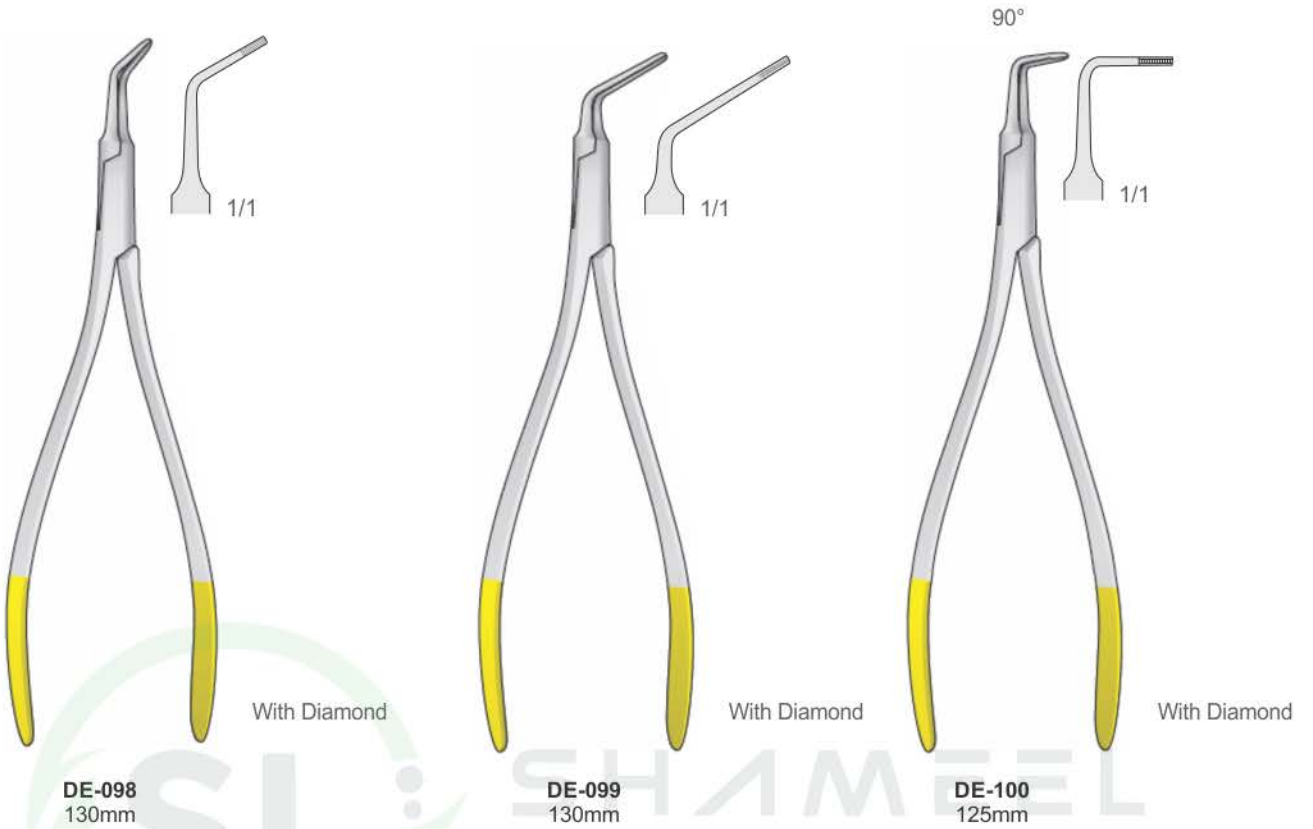

**DE-098**  
130mm

**DE-099**  
130mm

**DE-100**  
125mm



**DE-101**  
130mm

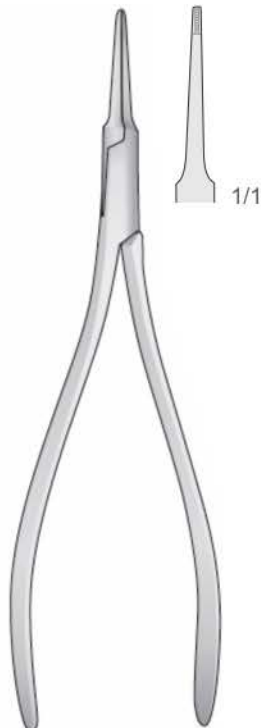

**DE-102**  
130mm



**DE-103**  
125mm

## EXTRACTING FORCEPS (American Pattern)



- Щипцы экстракционные (американская форма)
- Daviers - forme américaine
- Férceps de extracción - forma americana
- Щипці екстракційні (американська форма)
- Pinzeper per estrazione - forma americana
- استخراج الملقط (النمط الأمريكي)

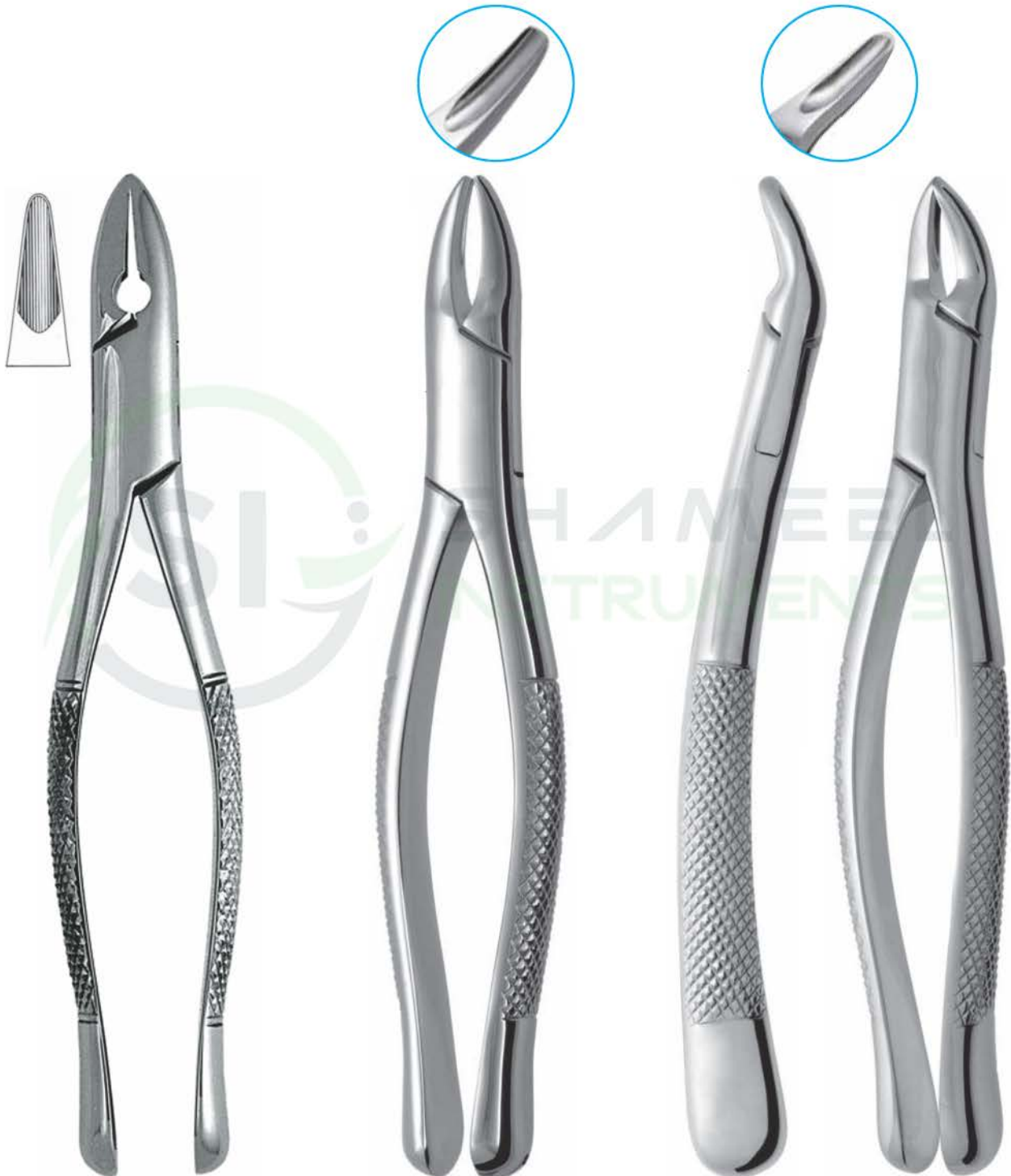

**DE-104**  
**# 1STD**  
Winter  
upper centrals and canines

**DE-105**  
Fig. 1  
upper incisors  
and roots

**DE-106**  
Cryer  
Fig. 150





## EXTRACTING FORCEPS (American Pattern)

- Щипцы экстракционные (американская форма)
- Щипці екстракційні (американська форма)
- Daviers - forme américaine
- Pinzeper per estrazione - forma americana
- Fórceps de extracción - forma americana
- استخراج الملقط (النمط الأمريكي)



**DE-107**  
Fig. 150A  
Cryer  
upper incisors, premolars, roots



**DE-108**  
Fig. 62  
incisors, premolars,  
deciduous teeth



**DE-109**  
# 10S  
upper roots



**DE-110**  
# 17  
lower molars



**DE-111**  
Harris  
Fig. 18R

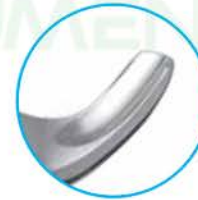

**DE-112**  
Harris  
Fig. 18L



SHAMEEL  
INSTRUMENTS

## EXTRACTING FORCEPS (American Pattern)



- Щипцы экстракционные (американская форма)
- Daviers - forme américaine
- Fórceps de extracción - forma americana
- Щипці екстракційні (американська форма)
- Pinzeper per estrazione - forma americana
- استخراج الملقط (النمط الأمريكي)



**DE-113**  
Fig. 210  
upper third molars



**DE-114**  
Fig. 53R  
upper molars, right



**DE-115**  
Fig. 53L  
upper molars, left



**DE-116**  
NEVIUS  
Fig. 88R







## EXTRACTING FORCEPS (American Pattern)

- Щипцы экстракционные (американская форма)
- Daviers - forme américaine
- Fórceps de extracción - forma americana
- Щипці екстракційні (американська форма)
- Pinzeper per estrazione - forma americana
- استخراج الملقط (النمط الأمريكي)



**DE-117**  
Fig. 24  
upper molars



**DE-118**  
# 210S  
upper third molars



**DE-119**  
# 210H  
upper third molars



**DE-120**  
# 286  
Upper Roots,  
Premolars, Incisors



**DE-121**  
# 99C  
Kells  
upper incisors,  
canines, premolars



**DE-122**  
# 222  
lower third molars



**DE-123**  
# 286  
Lower Molar

## EXTRACTING FORCEPS (American Pattern)

- Щипцы экстракционные (американская форма)
- Dавiers - forme américane
- Fórceps de extracción - forma americana
- Щипці екстракційні (американська форма)
- Pinzereper per estrazione - forma americana
- استخراج الملقط (النمط الأمريكي)



**DE-124**  
Nevius  
Fig. 88L  
upper molars, left



**DE-125**  
Fig. 65  
upper incisors  
and roots



**DE-126**  
Parmly Fig. 32A  
upper premolars  
and roots



**DE-127**  
Parmly Fig. 32  
upper premolars  
and molars





## EXTRACTING FORCEPS (American Pattern)

- Щипцы экстракционные (американская форма)
- Щипці екстракційні (американська форма)
- Daviers - forme américaine
- Pinzeper per estrazione - forma americana
- Fórceps de extracción - forma americana
- استخراج الملقط (النمط الأمريكي)

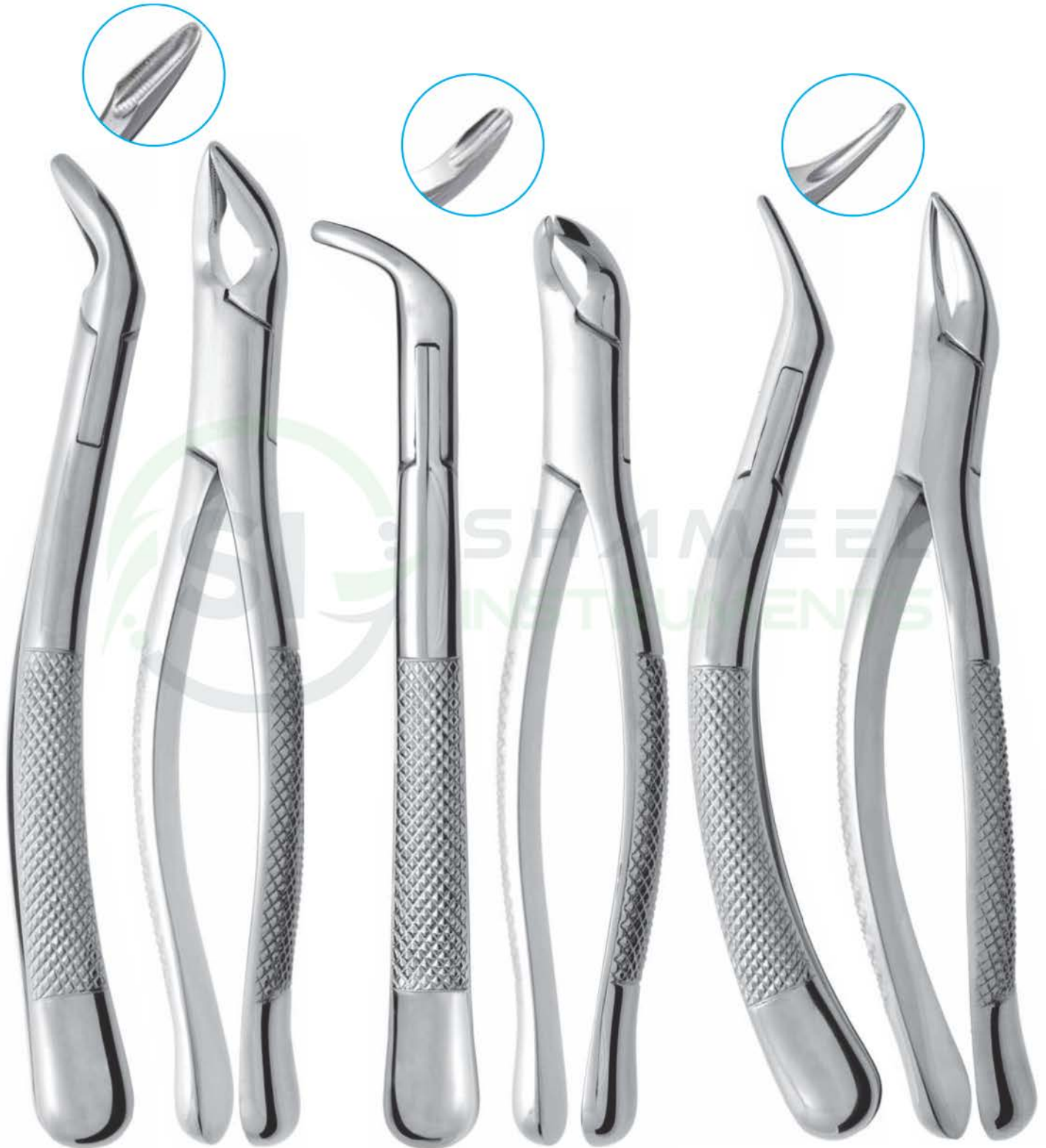

**DE-128**  
COHEN  
universal

**DE-129**  
Fig. 203  
lower incisors  
and roots

**DE-130**  
Tomes Fig. 69  
upper and lower  
roots

## EXTRACTING FORCEPS (American Pattern)



- Щипцы экстракционные (американская форма)
- Daviers - forme américaine
- Fórceps de extracción - forma americana
- Щипці екстракційні (американська форма)
- Pinzoper per estrazione - forma americana
- استخراج الملقط (النمط الأمريكي)



**DE-131**  
Fig. 23  
lower molars

**DE-132**  
Fig. 16  
lower molars

**DE-133**  
Physic Fig. 5  
lower third molars

**DE-134**  
Harris Fig. 15  
lower molars

**DE-135**  
Fig. 103



## EXTRACTING FORCEPS (American Pattern)

- Щипцы экстракционные (американская форма)
- Daviers - forme américaine
- Fórceps de extracción - forma americana
- Щипці екстракційні (американська форма)
- Pinzere per estrazione - forma americana
- استخراج الملقط (النمط الأمريكي)



**DE-136**  
Hull  
Fig. 101  
Deciduous teeth

**DE-137**  
Cryer  
Fig. 150S  
upper teeth,  
for children

**DE-138**  
Fig. 150 AS



## EXTRACTING FORCEPS (American Pattern)



- Щипцы экстракционные (американская форма)
- Daviers - forme américaine
- Fórceps de extracción - forma americana
- Щипці екстракційні (американська форма)
- Pinzaper per estrazione - forma americana
- استخراج الملقط (النمط الأمريكي)



**DE-139**  
Cryer  
Fig. 151  
lower teeth,  
for children

**DE-140**  
Fig. 151 S  
lower incisors,  
premolars, roots

**DE-141**  
Fig. 151 AS



## EXTRACTING FORCEPS (American Pattern)

- Щипцы экстракционные (американская форма)
- Щипці екстракційні (американська форма)
- Daviers - forme américaine
- Pinzere per estrazione - forma americana
- Fórceps de extracción - forma americana
- استخراج الملقط (النمط الأمريكي)



**DE-142**  
**# 16S**  
lower molars for children



**DE-143**  
**# 17S**  
lower molars



**DE-144**  
**# 23 S**  
Lower molars

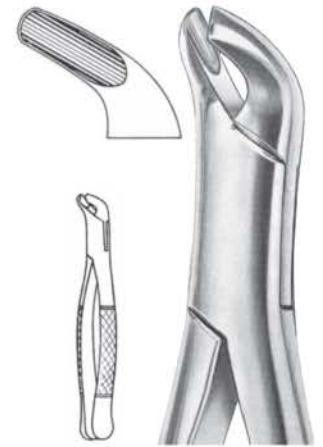

**DE-145**  
**# 27**  
lower molars



**DE-146**  
**# 18LS**  
upper molars left



**DE-147**  
**# 18RS**  
upper molars right



**DE-148**  
**# 85 Tomas**  
lower canines, premolars and molars



**DE-149**  
**# 85A Tomas**  
lower canines, premolars and molars



**DE-150**  
**# 69S**  
upper and lower roots



**DE-151**  
**# 99A Kells**  
upper incisors, canines, premolars

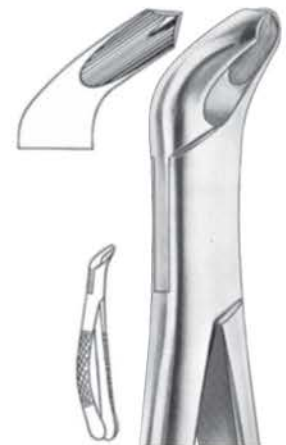

**DE-152**  
**# 217**  
lower molars

## EXTRACTING FORCEPS (American Pattern)



- Щипцы экстракционные (американская форма)
- Daviers - forme américaine
- Férceps de extracción - forma americana
- Щипці екстракційні (американська форма)
- Pinzener per estrazione - forma americana
- استخراج الملقط (النمط الأمريكي)



**DE-153**  
**#10 SK**  
Upper Molars Sup



**DE-154**  
**#17 SK Universal**  
Lower Molars



**DE-155**  
**#23 SK Universal**  
Upper Molars



**DE-156**  
**#69 SK Tomas**  
upper and lower roots



**DE-157**  
**#99 SK**  
upper incisors,  
canines, premolars



**DE-158**  
**#150 SK**  
upper incisors,  
premolars, roots



**DE-159**  
**#151 SK**  
lower incisors,  
premolars, roots



**DE-160**  
**#222 SK**  
lower third molars





## EXTRACTING FORCEPS (American Pattern)

- Щипцы экстракционные (американская форма)
- Daviers - forme américaine
- Fórceps de extracción - forma americana
- Щипці екстракційні (американська форма)
- Pinzaper per estrazione - forma americana
- استخراج الملقط (النمط الأمريكي)



**DE-161**  
Fig. 1  
Upper Anterior

**DE-162**  
Lower Molar  
Fig. 23 Cow Horn



**DE-163**  
Fig. 74  
Lower Anterior



**DE-164**  
Fig. 88L  
Upper Molar Left



**DE-165**  
Fig. 88R  
Upper Molar Right



**DE-166**  
Fig. 74  
Lower Anterior



**DE-167**  
Fig. 106  
Lower Incisors



**DE-168**  
Fig. 174  
Extra Narrow  
Lower Anterior  
Apical Retention  
Forceps



**DE-169**  
Fig. 859  
Lower Molars  
Roots



## EXTRACTING FORCEPS (American Pattern)

- Щипцы экстракционные (американская форма)
- Щипці екстракційні (американська форма)
- Daviers - forme américaine
- Pinzere per estrazione - forma americana
- Fórceps de extracción - forma americana
- استخراج الملقط (النمط الأمريكي)

### Carbide Diamond Coated Point



**DE-170**  
150 T.C.  
Carbide Serrated Beak  
Upper Incisors, Cuspids,  
Bicuspid & Roots,  
Universal



**DE-171**  
151 T.C.  
Carbide Serrated Beak  
Lower Incisors, Cuspids,  
Bicuspid & Roots, Universal



**DE-172**  
151STD T.C.  
Carbide Serrated Beak  
Upper Incisors, Cuspids,



**DE-173**  
17 T.C.  
Carbide Serrated Beak  
1st & 2nd Lower Molars,  
Universal



**DE-174**  
53L T.C.  
Carbide Serrated Beak  
1st & 2nd Upper Molars,  
Left



**DE-175**  
53R T.C.  
Carbide Serrated Beak  
1st & 2nd Upper Molars,  
Right



**DE-176**  
65 T.C.  
Carbide Serrated Beak  
Upper Incisors, Roots &  
Fragments



**DE-177**  
69 T.C.  
Carbide Serrated Beak  
Upper & Lower Fragments  
And Roots



**DE-178**  
150S T.C. Pedo forcep  
Carbide Serrated Beak  
Pedo, Upper Primary Teeth  
and Roots, Universal



**DE-179**  
151S T.C. Pedo forcep  
Carbide Serrated Beak  
Pedo, Lower Primary Teeth  
and Roots, Universal



## BONE ROUNGER

- Костные кусачки
- Hohlmeißelzangen
- Pincés-gouges
- Кусачки для кісток
- Pinzas-gubias
- روتجیورس العظام



**DE-180**  
Blumenthal  
15cm



**DE-181**  
Blumenthal  
15cm



**DE-182**  
Blumenthal  
15cm



**DE-183**  
Friedman  
14cm



**DE-184**  
Friedman  
14.5cm



**DE-185**  
Micro-Friedman  
14cm



**DE-186**  
Micro-Friedman  
15cm



**DE-187**  
Micro-Friedman  
16cm



**DE-188**  
Kleinert-Kutz  
18.5cm



**DE-189**  
Beyer  
18.5cm



**DE-190**  
Mead 1A  
18.5cm



**DE-191**  
Luer  
18.5cm



## EXTRACTING FORCEPS (English Pattern)

- Щипцы экстракционные (английская форма)
- Daviers (Forme Anglaise)
- Zahnzangen (Englische Form)
- Щипці екстракційні (англійська форма)
- Forceps de Extracción (Forme Inglesa)
- استخراج الملقط (نمط اللغة الإنجليزية)

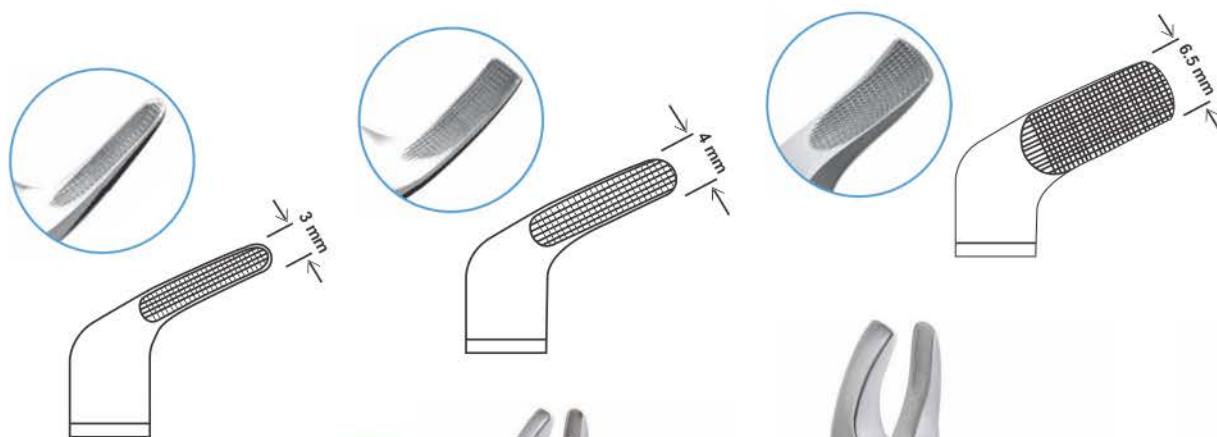

**DE-192**  
Meissner  
Extracting Forceps



**DE-193**  
Meissner  
Extracting Forceps



**DE-194**  
Meissner  
Extracting Forceps



**DE-195**  
Comellas Forceps  
Anatomical Handle



# DENTAL SYRINGES

- Шприцы стоматологические карпульные
- Шприці стоматологічні карпульні
- Seringues à usage dentaire
- Jeringas dentales
- Dentalspritzen
- المحاقن الأسنان



DE-196 1.8ml  
DE-197 2.2ml



DE-198 1.8ml  
DE-199 2.2ml



DE-200 1.8ml  
DE-201 2.2ml



DE-202 1.8ml  
DE-203 2.2ml



DE-204 1.8ml  
DE-205 2.2ml



DE-206 1.8ml  
DE-207 2.2ml



DE-208  
# 1001  
Intraligamental  
Anesthesia  
Syringe in  
Black Colour



DE-209 1.8ml  
DE-210 2.2ml  
Angled



DE-211  
Aluminium - Dark 1.8 ml

- DE-212 Aluminium - Silver 1.8 ml
- DE-213 Aluminium - Orange 1.8 ml
- DE-214 Aluminium - Green 1.8 ml
- DE-215 Aluminium - Blue 1.8 ml



Type C  
DE-216 1,8ml  
DE-217 2,2ml



Type C  
DE-218 1,8ml  
DE-219 2,2ml



2-Ring  
DE-220 1,8ml  
DE-221 2,2ml



Aspirating Syringe  
DE-222 1.8mm  
DE-223 2.2mm



Cartridge Syringe  
DE-224 1.8mm  
DE-225 2.2mm



Cartridge Syringe  
DE-226 1.8mm  
DE-227 2.2mm



Cartridge Syringe  
DE-228 1.8mm  
DE-229 2.2mm

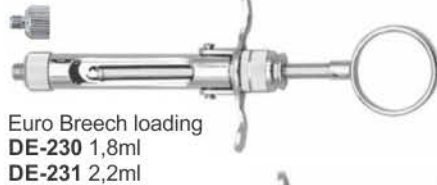

Euro Breech loading  
DE-230 1,8ml  
DE-231 2,2ml

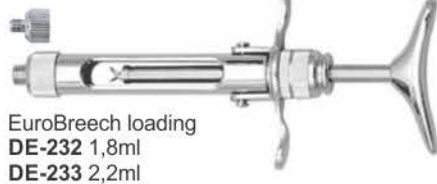

EuroBreech loading  
DE-232 1,8ml  
DE-233 2,2ml



Manual Aspirating Syringe  
DE-234 1,8ml  
DE-235 2,2ml



Quatro  
DE-236 1,8ml  
DE-237 2,2ml



Trio  
DE-238 1,8ml  
DE-239 2,2ml



Swedish Type  
DE-240 1,8ml  
DE-241 2,2ml



Ject Ultima  
DE-242 1,8ml  
DE-243 2,2ml  
Injects 0,05 ml with every click Supplied with angled and straight tubes



Ject angled  
DE-244 1,8ml  
DE-245 2,2ml

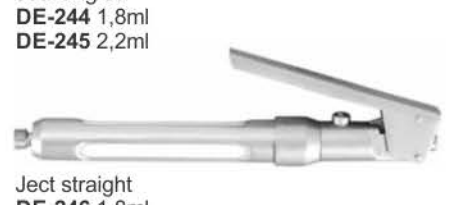

Ject straight  
DE-246 1,8ml  
DE-247 2,2ml



Disc System  
DE-248 1,8ml  
DE-249 2,2ml



Disc System  
DE-250 1,8ml



# EXTRACTING FORCEPS SET



Извлечение щипцов  
Ensemble de pinces d'extraction  
• Zange sammeln

• Витягуючий комплект щипців  
• Extracción del conjunto de fórceps  
• استخراج ملقط مجموعة



**DE-251**  
Extracting Forceps  
Set of 10 Pieces  
Extracting Forceps Fig. 2  
Extracting Forceps Fig. 7  
Extracting Forceps Fig. 13  
Extracting Forceps Fig. 17  
Extracting Forceps Fig. 18  
Extracting Forceps Fig. 22  
Extracting Forceps Fig. 33  
Extracting Forceps Fig. 51A  
Extracting Forceps Fig. 67A  
Extracting Forceps Fig. 79



**DE-252**  
Extracting Forceps  
Set of 10 Pieces  
Extracting Forceps Fig. 2  
Extracting Forceps Fig. 7  
Extracting Forceps Fig. 13  
Extracting Forceps Fig. 17  
Extracting Forceps Fig. 18  
Extracting Forceps Fig. 22  
Extracting Forceps Fig. 33  
Extracting Forceps Fig. 51A  
Extracting Forceps Fig. 67A  
Extracting Forceps Fig. 79



**DE-253**  
Extracting Forceps  
Set of 13 Pieces  
Extracting Forceps Fig. 2  
Extracting Forceps Fig. 7  
Extracting Forceps Fig. 13  
Extracting Forceps Fig. 17  
Extracting Forceps Fig. 18  
Extracting Forceps Fig. 22  
Extracting Forceps Fig. 33  
Extracting Forceps Fig. 51A  
Extracting Forceps Fig. 67A  
Extracting Forceps Fig. 79  
Extracting Forceps Fig. 86C  
Extracting Forceps Fig. 89  
Extracting Forceps Fig. 90



**DE-254**  
Extracting Forceps Children Pattern  
Set of 10 Pieces  
Extracting Forceps Fig. 13S  
Extracting Forceps Fig. 22S  
Extracting Forceps Fig. 30S  
Extracting Forceps Fig. 33S  
Extracting Forceps Fig. 37  
Extracting Forceps Fig. 38  
Extracting Forceps Fig. 39  
Extracting Forceps Fig. 39L  
Extracting Forceps Fig. 39R  
Extracting Forceps Fig. 51S



**DE-255**  
Extracting Forceps English adult Adult  
Set of 10 Pcs



**DE-256**  
Extracting Forceps American Adult  
Set of 10 Pcs



**DE-257**  
Extracting Forceps American Adult  
Set of 8 Pcs



**DE-258**  
Extracting Forceps Pedro  
Set of 7 Pcs





# ROOT ELEVATOR

## FUNCTION OF ROOT ELEVATORS IN SURGERY

To Loosen Tooth or Root From Bony Socket Prior to Placement of The Extraction Forceps.

### HANDLES FOR ROOT ELEVATORS POINTS A, B, C, D, E, F, G, H



# ROOT ELEVATOR

- Элеватор корневой экстракционный
- Elévateurs à racines
- Wurzelheber
- Слеватор корневий екстракційний
- Elevadores para raices
- المصاعد الجذر

## Function of Root Elevators:

To loosen tooth or root from bony socket prior to placement of the extraction forceps.

### Apexo Root Elevators



### Luxator Root Elevators



### Bein Root Elevators

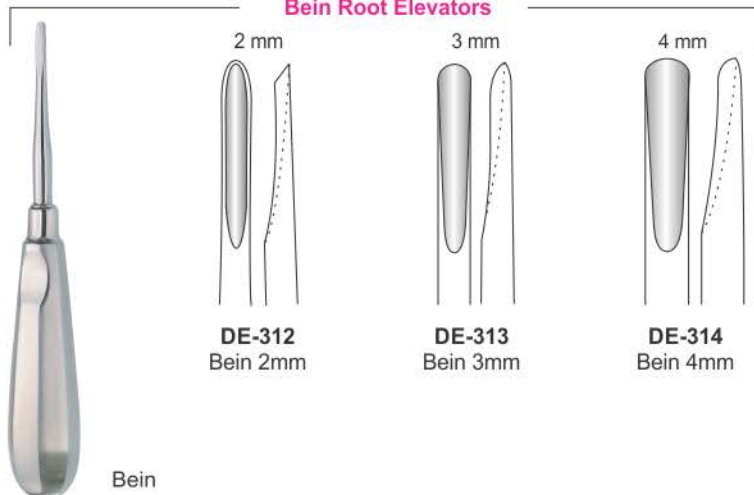

### Seldin Root Elevators

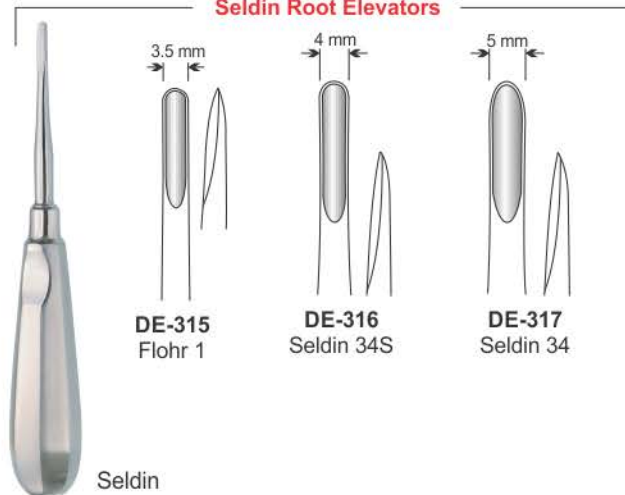



# ROOT ELEVATOR

- Элеватор корневой экстракционный
- Слеватор кореневий екстракційний
- Elévateurs à racines
- Elevadores para raices
- Wurzelheber
- المصاعد الجذر

**FUNCTION:** To loosen tooth or root from bony socket prior to placement of the extraction forceps.

## Laxutor Root Elevators

Long Type



Laxutor Root Elevator



DE-318  
Laxutor  
1.5mm  
Str.



DE-319  
Laxutor  
2mm  
Str.



DE-320  
Laxutor  
3mm  
Str.



DE-321  
Laxutor  
5mm  
Str.



DE-322  
Laxutor  
3mm  
Cvd.



DE-323  
Laxutor  
5mm  
Cvd.



DE-324  
Laxutor  
3mm  
Upper Angle



DE-325  
Laxutor  
3mm  
Double Angle



DE-326  
Laxutor  
3mm  
Str.



DE-327  
Laxutor  
5mm  
Str.





# ROOT ELEVATOR

- Элеватор корневой экстракционный
- Elévateurs à racines
- Wurzelheber
- Слеватор корневий экстракційний
- Elevadores para raices
- المصاعد الجذر

## Laxutor Root Elevators

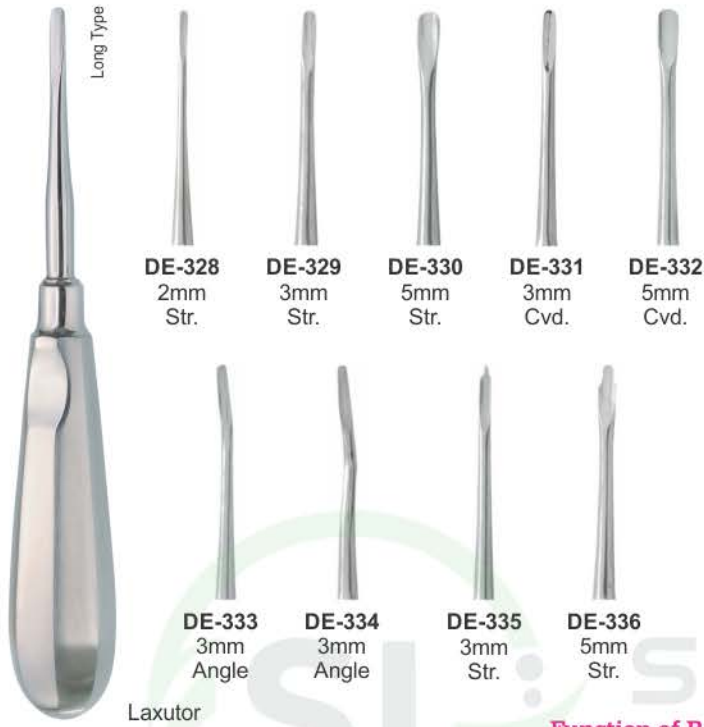

lower roots elevator



Upper root elevator with helicoidal tip

## Luxator Roots Elevator



DE-337 Luxator Straight

DE-338 Luxator Curved

### Function of Root Elevators:

To loosen tooth or root from bony socket prior to placement of the extraction forceps.

## Apical Root Elevators

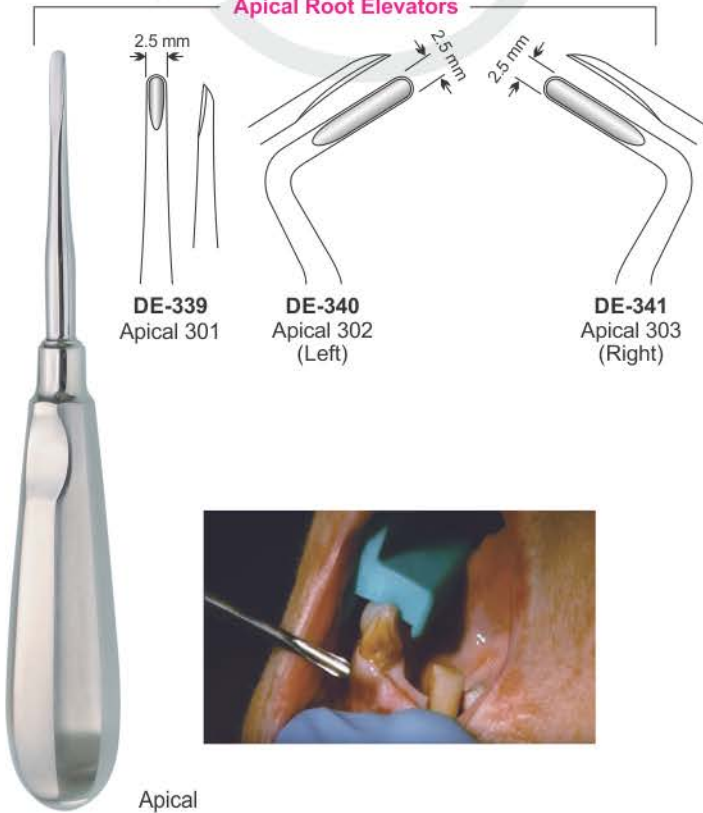

Apical

## Apical Root Elevators

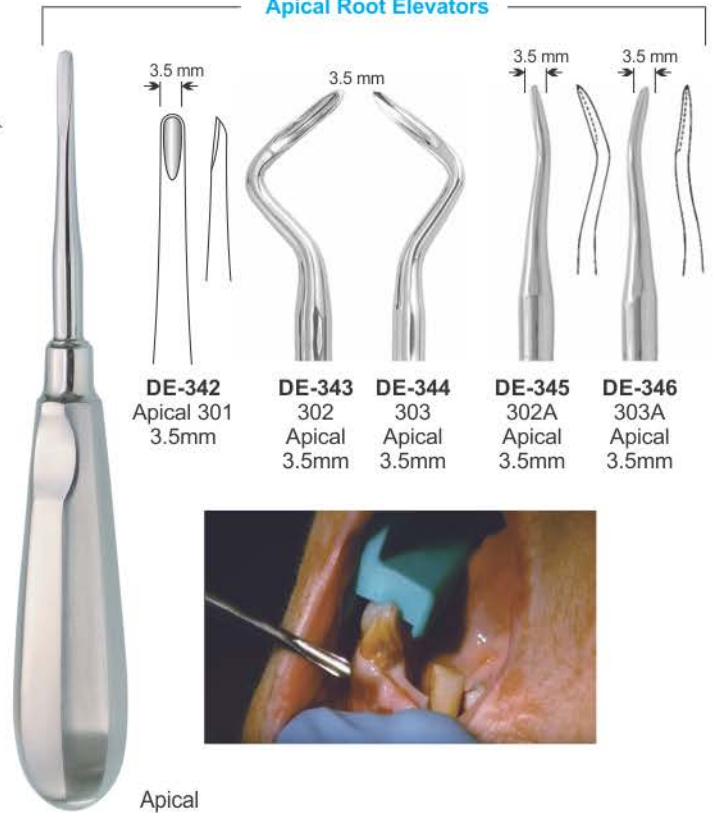

Apical

# ROOT ELEVATOR

- Элеватор корневой экстракционный
- Elévateurs à racines
- Wurzelheber
- Слеватор корневий екстракційний
- Elevadores para raices
- المصاعد الجذر

**FUNCTION:** To Loosen Tooth or Root From Bony Socket Prior to Placement of The Extraction Forceps.

## Cryer Root Elevators

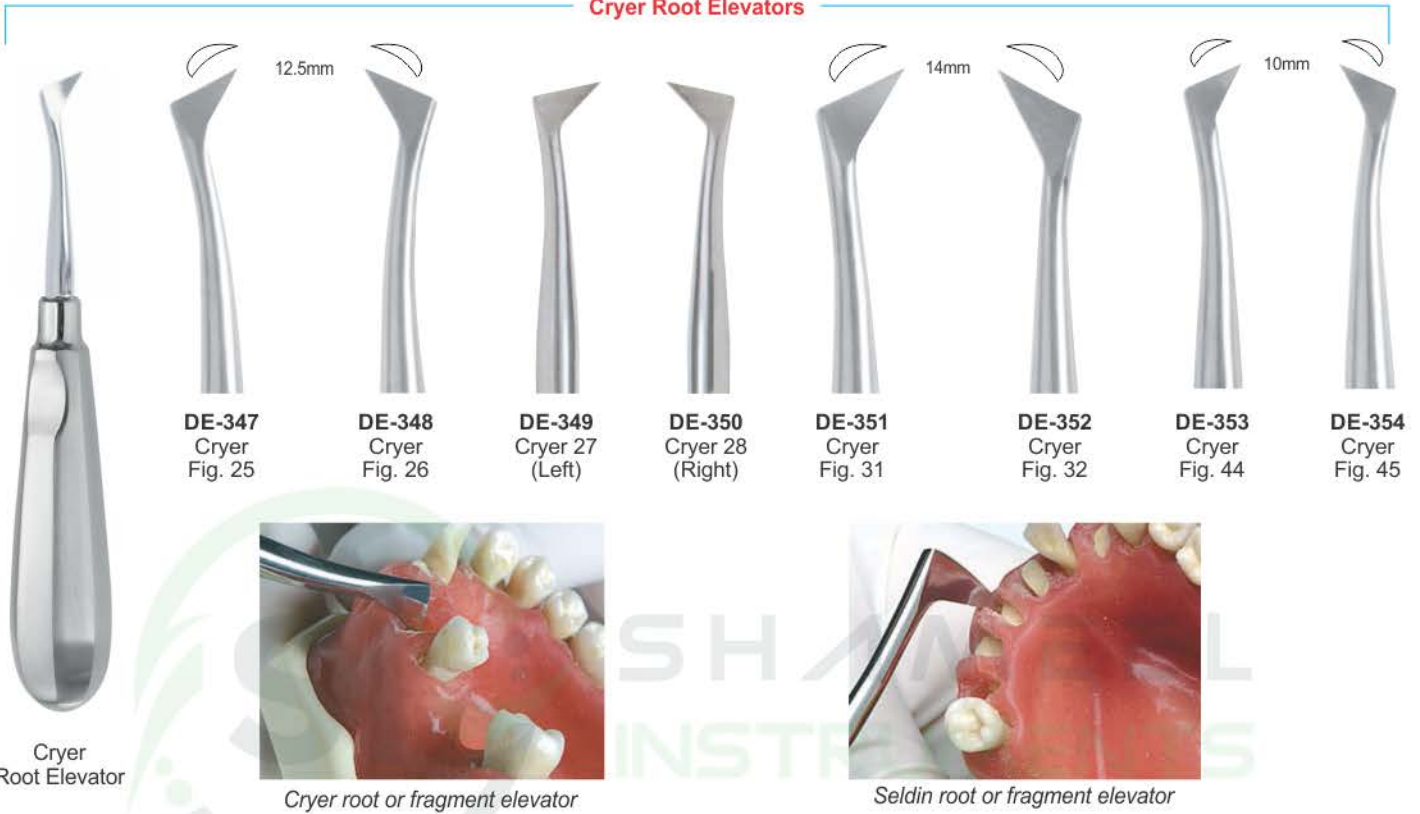

## Seldin Root Elevators

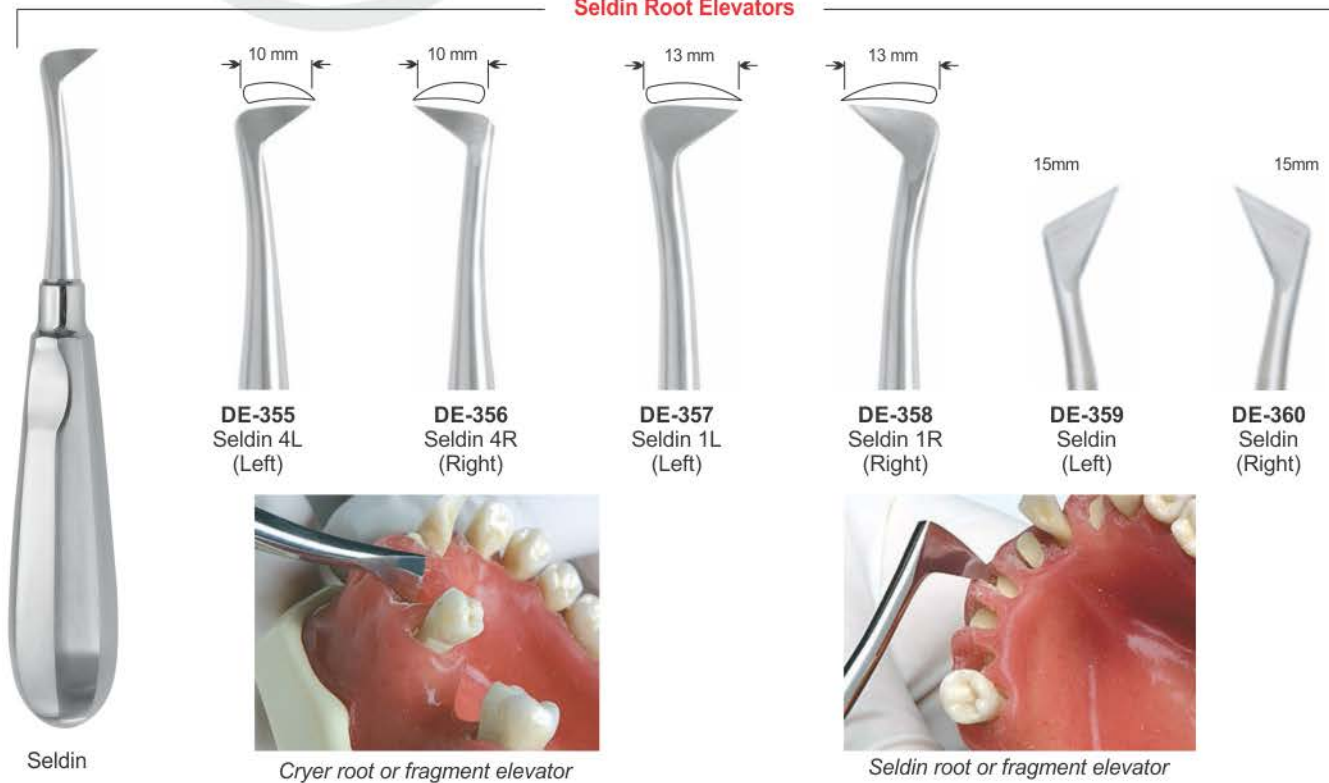

# ROOT ELEVATOR

- Элеватор корневой экстракционный
- Elévateurs à racines
- Wurzelheber
- Слеватор корневий экстракційний
- Elevadores para raices
- المصاعد الجذر

**FUNCTION:** To Loosen Tooth or Root From Bony Socket Prior to Placement of The Extraction Forceps.

## Apical Root Elevators

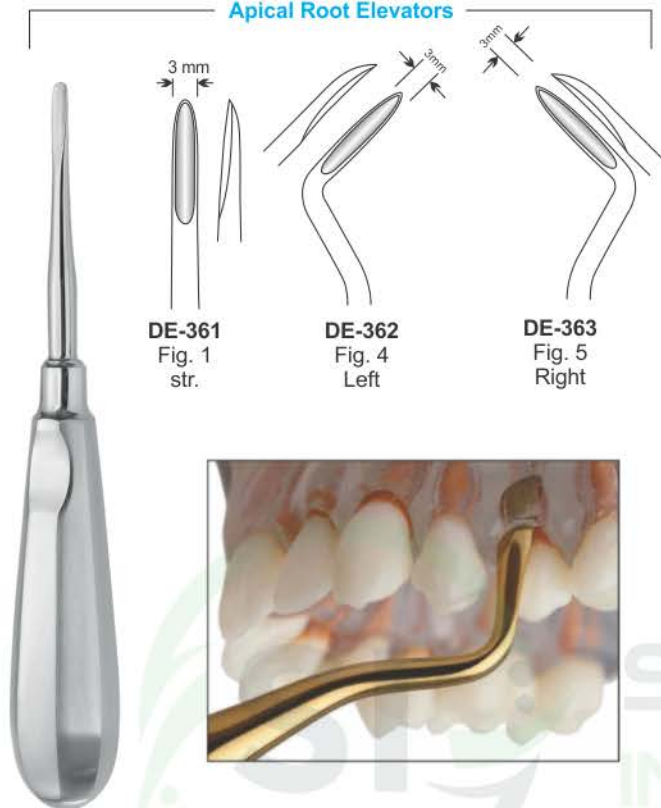

## Apical Root Elevators

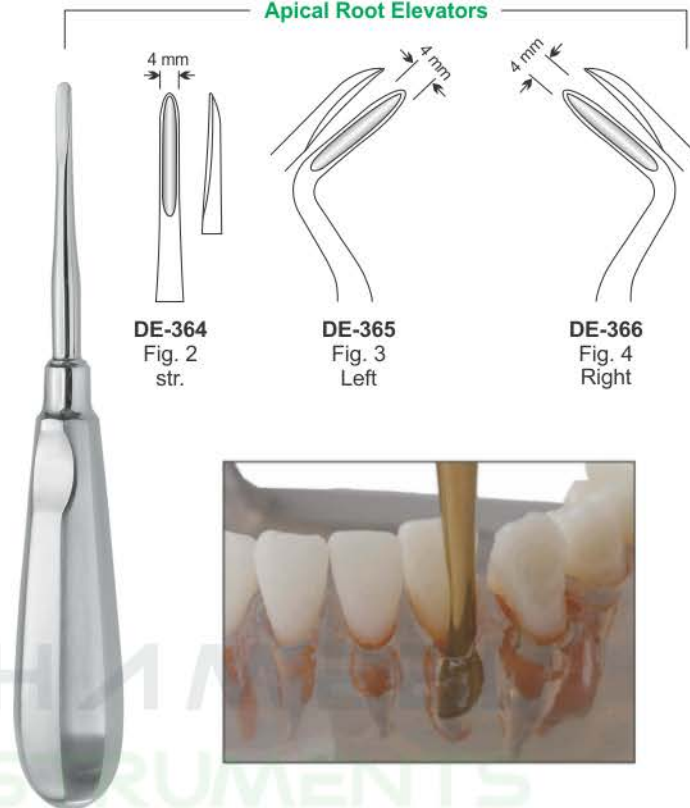

## Flohr Root Elevators



## Heidbrink Root Elevators

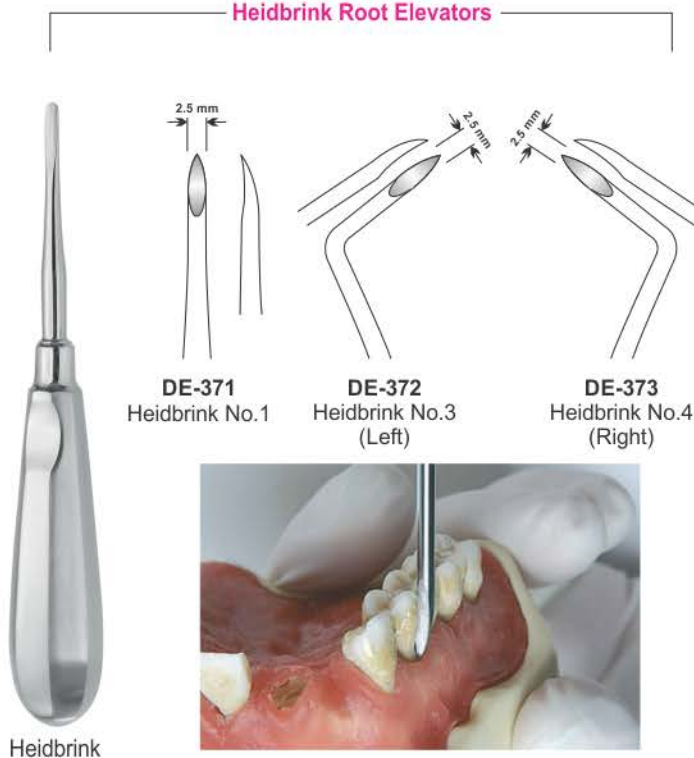



# ROOT ELEVATOR

- Элеватор корневой экстракционный
- Elévateurs à racines
- Wurzelheber
- Слеватор корневий экстракційний
- Elevadores para raices
- المصاعد الجذر

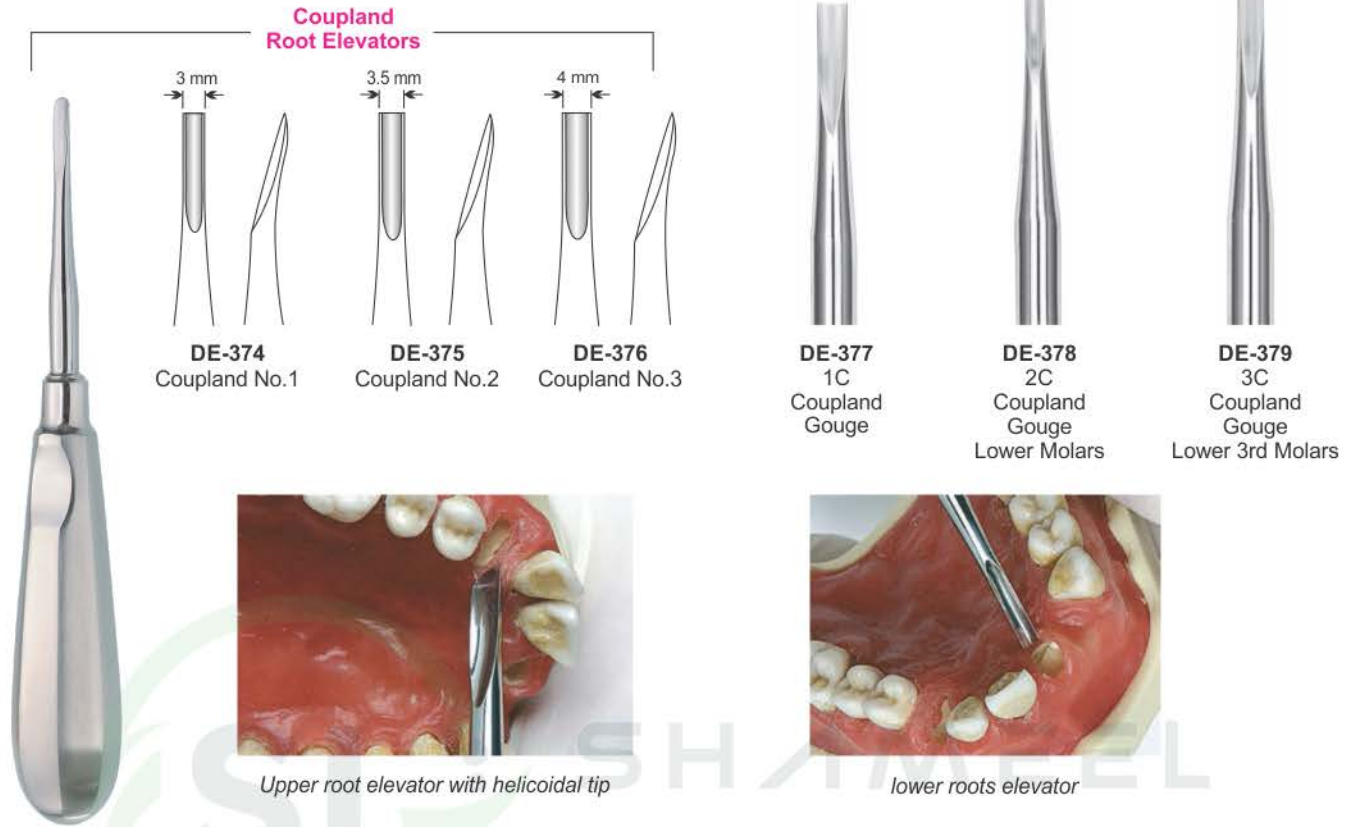

**FUNCTION:** To Loosen Tooth or Root From Bony Socket Prior to Placement of The Extraction Forceps.

## ENGLISH PATTERNS



universal mini-elevator for fragments

# ROOT ELEVATOR

- Элеватор корневой экстракционный
- Elévateurs à racines
- Wurzelheber
- Слеватор корневий екстракційний
- Elevadores para raices
- المصاعد الجذر

## Lindo Levian Root Elevators

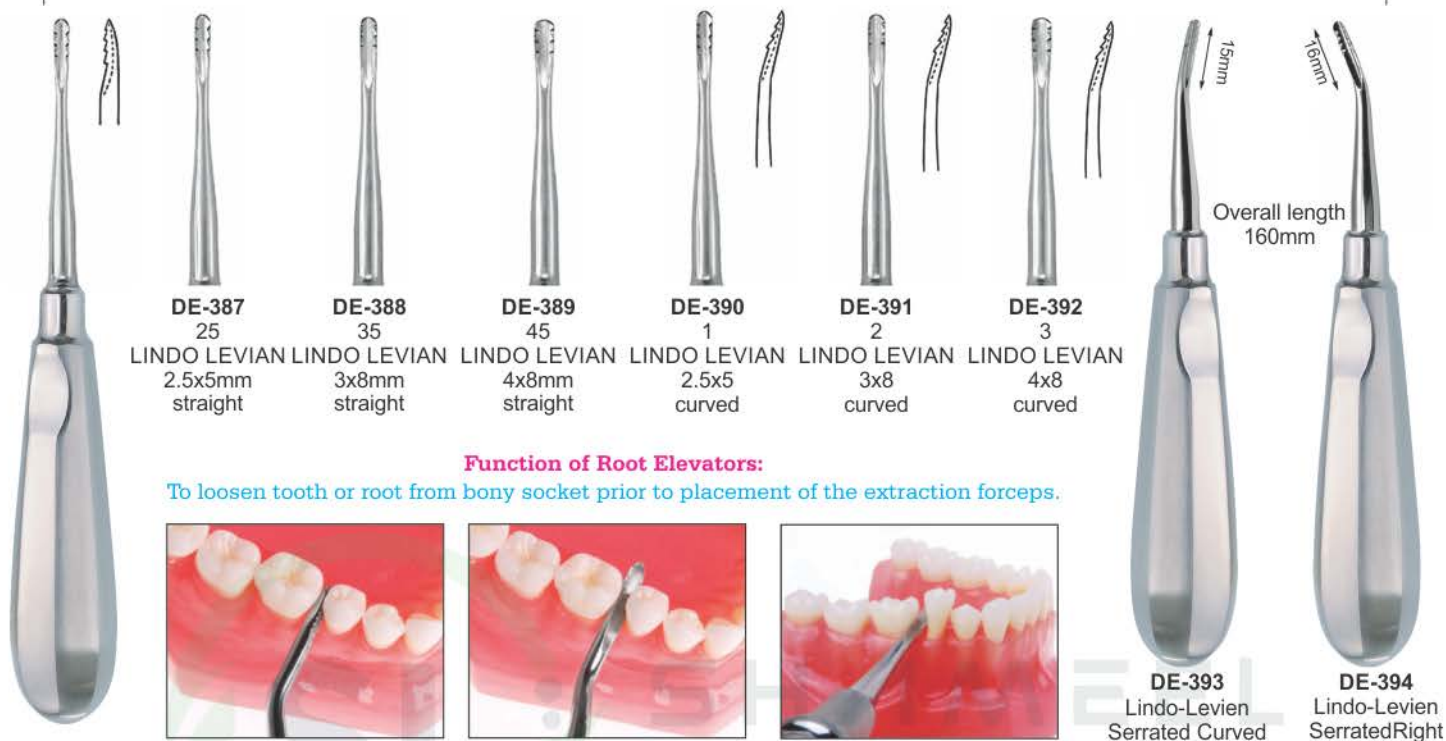



# ROOT ELEVATOR

- Элеватор корневой экстракционный
- Elévateurs à racines
- Wurzelheber
- Слеватор корневий екстракційний
- Elevadores para raices
- المصاعد الجذر

## Friedmann Roots Elevator



**DE-402**  
Friedmann 4F  
Str.

**DE-403**  
Friedmann 5F  
Left

**DE-404**  
Friedmann 6F  
Right

## Luxating Elevator With Periotome Tip



**DE-405**  
3mm Luxating  
Elevator / Periotome

**DE-406**  
4mm Luxating  
Elevator / Periotome

**DE-407**  
5mm Luxating  
Elevator / Periotome

## Wisdom Roots Elevator



**DE-408**  
Wisdom  
for 18 and 38

**DE-409**  
Wisdom  
for 28 and 48

**Function of Root Elevators:** To loosen tooth or root from bony socket prior to placement of the extraction forceps.

## Bayonet Roots Elevator Set



**DE-410**  
Left

**DE-411**  
Right

**DE-412**  
bayonet

**DE-413**  
Curved

**DE-414**  
Straight



# ROOT ELEVATOR

- Элеватор корневой экстракционный
- Elévateurs à racines
- Wurzelheber
- Слеватор корневий екстракційний
- Elevadores para raices
- المصاعد الجذر



**Function of Root Elevators:** To loosen tooth or root from bony socket prior to placement of the extraction forceps.

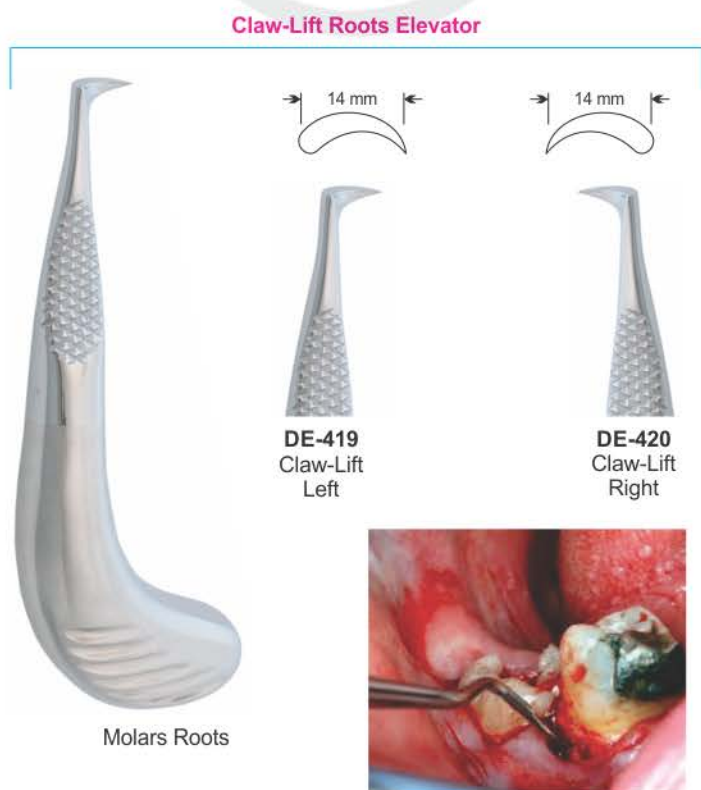



## ROOT ELEVATOR

- Элеватор корневой экстракционный
- Elévateurs à racines
- Wurzelheber
- Слеватор корневий екстракційний
- Elevadores para raices
- المصاعد الجذر

**FUNCTION:** To Loosen Tooth or Root From Bony Socket Prior to Placement of The Extraction Forceps.

**Laxutor Root Elevators Set of 9 Pcs**



DE-424  
2mm Str.



DE-425  
3mm Str.



DE-426  
5mm Str.



DE-427  
3mm Cvd.



DE-428  
5mm Cvd.



DE-429  
3mm Angle



DE-430  
3mm Angle



DE-431  
3mm Str.



DE-432  
5mm Str.

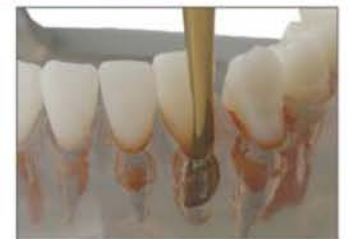

# ROOT ELEVATOR

- Элеватор корневой экстракционный
- Elévateurs à racines
- Wurzelheber
- Слеватор корневий экстракційний
- Elevadores para raices
- المصاعد الجذر

## Hylin Roots Elevator



**Function of Root Elevators:** To loosen tooth or root from bony socket prior to placement of the extraction forceps.

## Kopp Roots Elevator

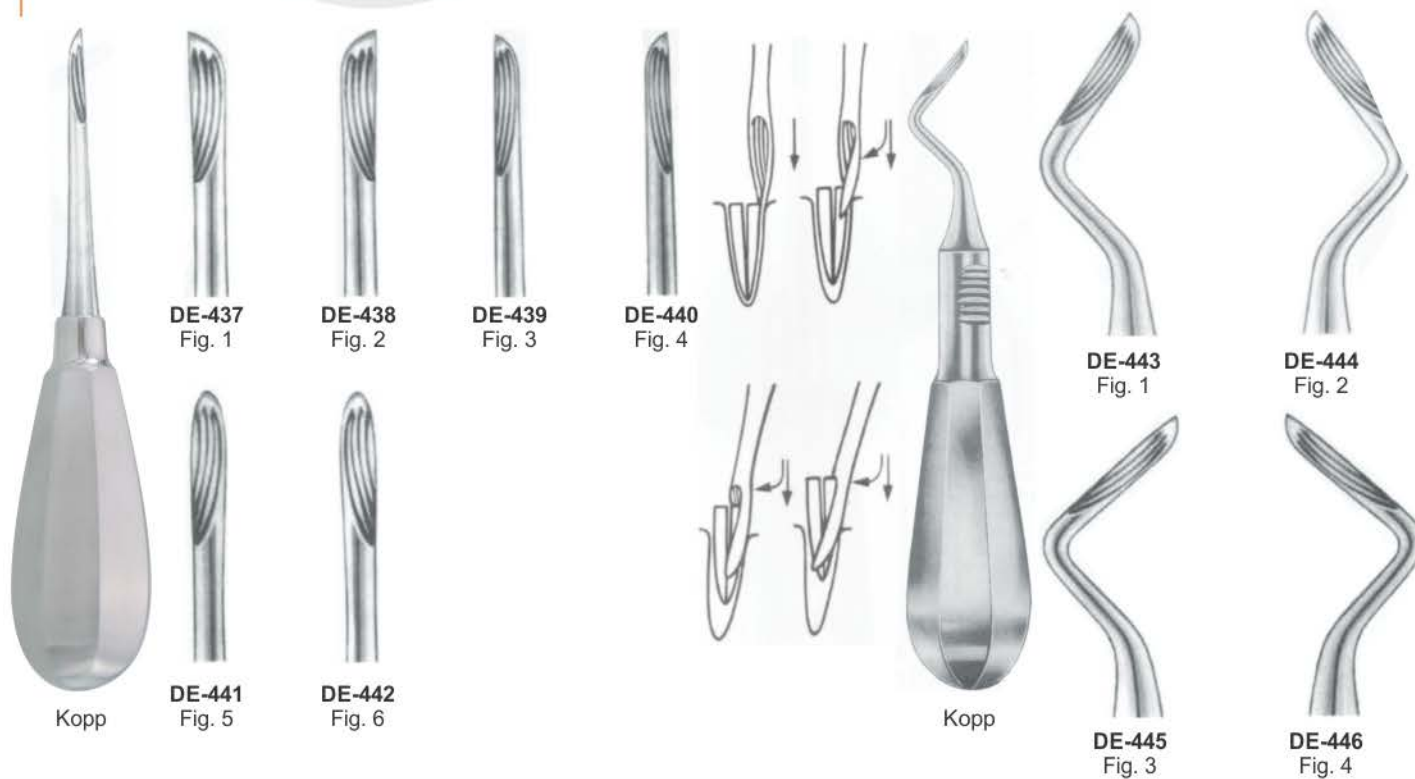





# ROOT ELEVATOR

- Элеватор корневой экстракционный
- Elévateurs à racines
- Wurzelheber
- Слеватор корневий екстракційний
- Elevadores para raices
- المصاعد الجذر

## Luxier Roots Elevator



DE-447  
Luxier  
Cvd.

DE-448  
Luxier  
Str.

## Heber Roots Elevator



DE-449  
Heber  
Bayonet

DE-450  
Heber  
Bayonet

## Bein Roots Elevator



DE-451  
Bein,  
3mm

DE-452  
Bein,  
4mm

**Function of Root Elevators:** To loosen tooth or root from bony socket prior to placement of the extraction forceps.

## Bein Roots Elevator



DE-454  
2mm  
straight  
serrated

DE-455  
3mm  
straight

DE-456  
4mm  
Curved

DE-458  
2mm  
straight  
serrated

DE-459  
3mm  
straight

DE-460  
4mm  
Curved

DE-462  
2mm  
straight  
serrated

DE-463  
3mm  
straight

DE-464  
4mm  
Curved

DE-453  
Bein  
2mm, curved  
serrated

DE-457  
Bein  
2mm, curved  
serrated

DE-461  
Bein  
2mm, curved  
serrated

# ROOT ELEVATOR

- Элеватор корневой экстракционный
- Elévateurs à racines
- Wurzelheber
- Слеватор кореневий екстракційний
- Elevadores para raices
- المصاعد الجذر

## W. Barry Roots Elevator



W. Barry  
Fig. 1  
(125mm)



DE-465  
W. Barry  
Fig. 1

DE-466  
W. Barry  
Fig. 2

DE-467  
W. Barry  
Fig. 3

DE-468  
W. Barry  
Fig. 4

**Function of Root Elevators:** To loosen tooth or root from bony socket prior to placement of the extraction forceps.



Winter  
Fig. 1L  
125mm



DE-469  
Winter  
Fig. 1L



DE-470  
Winter  
Fig. 1R



DE-471  
775/3  
Winter  
11 L



DE-472  
775/4  
Winter  
11 R



DE-473  
775/5  
Winter  
12 L



DE-474  
775/6  
Winter  
12 R



DE-475  
775/7  
Winter  
13 L



DE-476  
775/8  
Winter  
13 R



DE-477  
Winter  
Fig. 1L



DE-478  
Winter  
Fig. 1R



DE-479  
Lecluse  
bayonet



DE-480  
Potts "T-Handle"  
Elevator-Left



DE-481  
Potts "T-Handle"  
Elevator-Right

# ROOT ELEVATOR

- Элеватор корневой экстракционный
- Elévateurs à racines
- Wurzelheber
- Слеватор корневий екстракційний
- Elevadores para raices
- المصاعد الجذر



DE-482  
Fig. 1  
Chompret



DE-483  
Fig. 2  
Chompret



DE-484  
Fig. 3  
Chompret



DE-485  
Fig. 4  
Chompret



*Lecluse elevator for lower third molar dislocation*



*Chompret syndesmotome, sickle pattern*

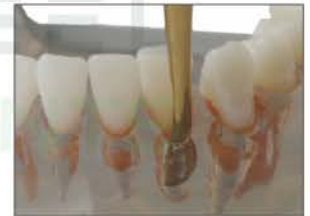

DE-486



DE-487



DE-488



DE-489



DE-490



DE-491



DE-492

## Root Pick Elevator With Gold Flexible Points



# ROOT ELEVATOR

- Элеватор корневой экстракционный
- Elévateurs à racines
- Wurzelheber
- Слеватор кореневий екстракційний
- Elevadores para raices
- المصاعد الجذر

## Heidbrink Roots Elevator



**DE-493**  
Heidbrink  
Straight

**DE-494**  
Heidbrink  
Left

**DE-495**  
Heidbrink  
Right

**DE-496**  
Heidbrink  
Straight

**DE-497**  
Heidbrink  
Left

**DE-498**  
Heidbrink  
Right

## Syndesmotomes Roots Elevator



**DE-499**  
Straight

**DE-500**  
Left

**DE-501**  
Right

## Periotome Roots Elevator



**DE-502**  
Periotome  
2.1mm  
Straight

**DE-503**  
Periotome  
2.6mm  
Straight

**DE-504**  
Periotome  
2.1mm  
Angular

**DE-505**  
Periotome  
2mm  
Curved

**DE-506**  
Periotome  
2.0mm

**DE-507**  
Periotome  
2.5mm

**DE-508**  
Periotome  
3.0mm

**DE-509**  
Periotome  
4.0mm

Syndesmotomes

# ROOT ELEVATOR

- Элеватор корневой экстракционный
- Слеватор кореневий екстракційний
- Elévateurs à racines
- Elevadores para raices
- Wurzelheber
- المصاعد الجذر

**FUNCTION:** To loosen small root fragments from bony socket

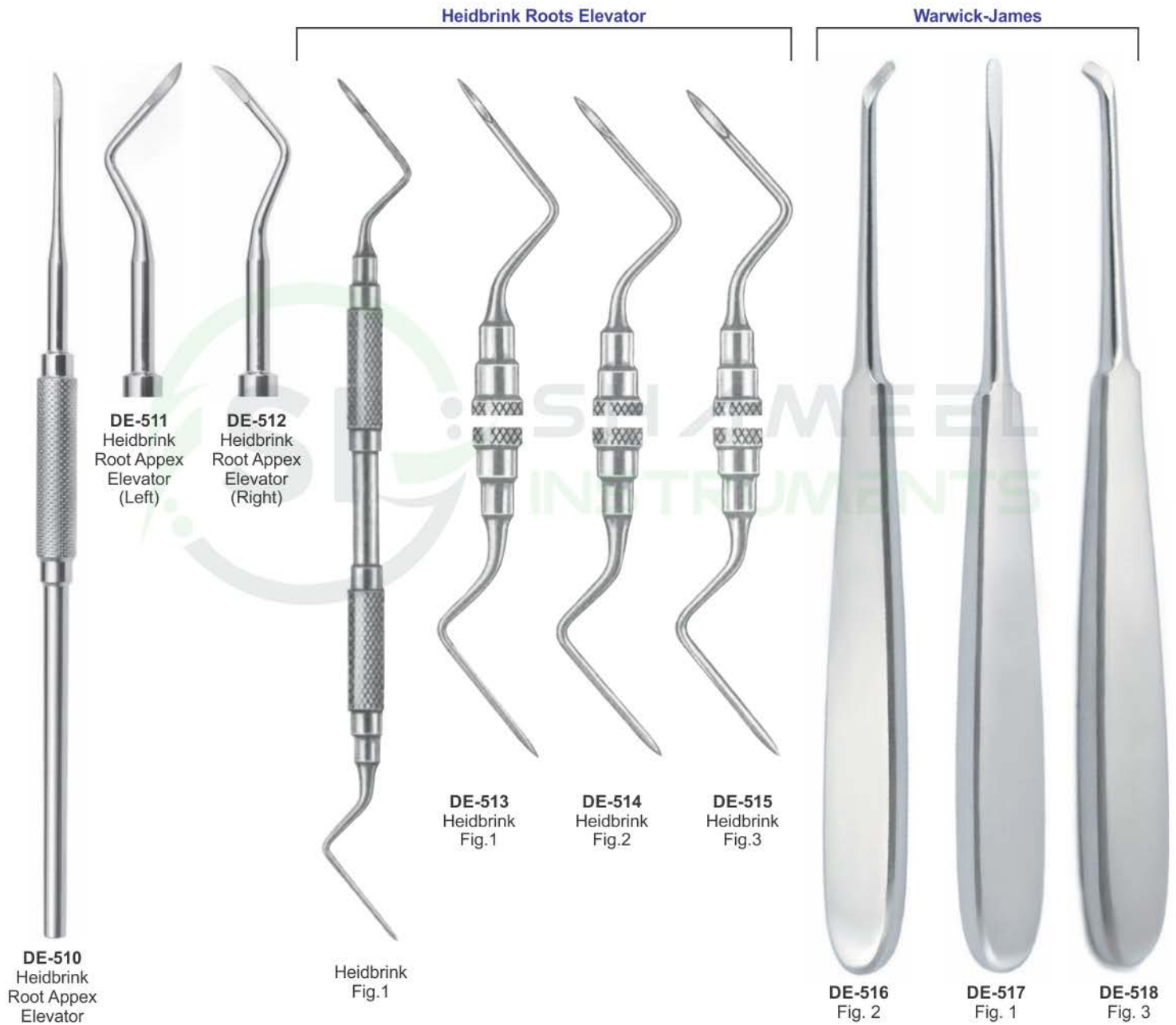

# ROOT ELEVATOR

- Элеватор корневой экстракционный
- Elévateurs à racines
- Wurzelheber
- Слеватор корневий екстракційний
- Elevadores para raíces
- المصاعد الجذر



**DE-519**  
1S  
(Straight 1mm)



**DE-520**  
2S  
(Straight 2mm)



**DE-521**  
3S  
(Straight 3mm)



**DE-522**  
5S  
(Straight 5mm)



**DE-523**  
3C  
(Curved 3mm)



**DE-524**  
5C  
(Curved 5mm)



**DE-525**  
3CA  
(Curved Angle 3mm)



**DE-526**  
3IC  
(Inverted Curved 3mm)



**DE-527**  
DE 3  
(Dual Edge 3mm / 1.5mm)



**DE-528**  
DE 5  
(Dual Edge 5mm / 3mm)





## ROOT ELEVATOR

- Элеватор корневой экстракционный
- Elévateurs à racines
- Wurzelheber
- Слеватор корневий екстракційний
- Elevadores para raices
- المصاعد الجذر

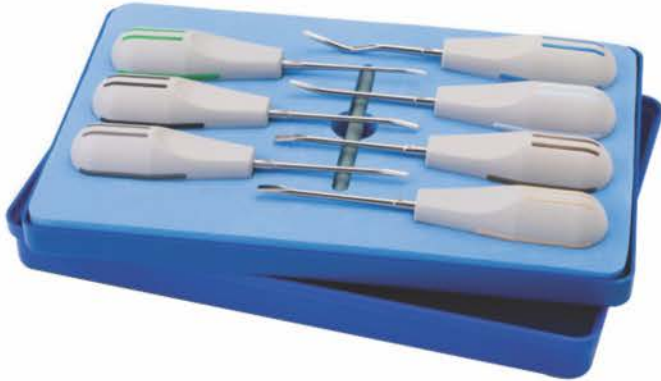

**DE-529**  
Luxators Set of 7 Pcs



**DE-530**  
Luxators Set of 7 Pcs



**DE-531**  
Luxators Set of 8 Pcs



**DE-532**  
Root Elevators Set of 10 Pcs



**DE-533**  
Elevators Set of 8 Pcs



**DE-534**  
Elevators Set of 8 Pcs

# ROOT ELEVATOR

- Элеватор корневой экстракционный
  - Elévateurs à racines
  - Wurzelheber
- Слеватор корневий екстракційний
  - Elevadores para raices
  - المصاعد الجذر

## PDL ELEVATORS

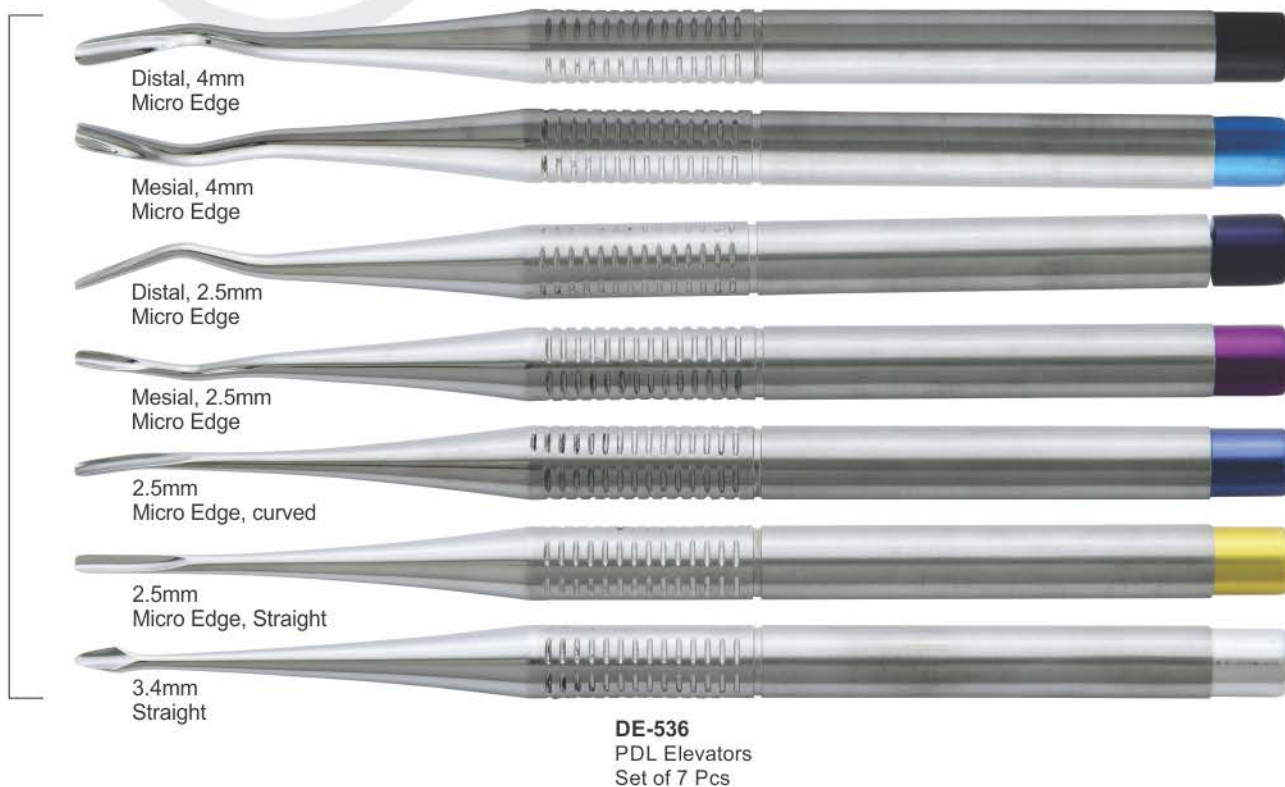



# ROOT ELEVATOR

- Элеватор корневой экстракционный
- Elévateurs à racines
- Wurzelheber
- Слеватор корневий екстракційний
- Elevadores para raices
- المصاعد الجذر

## PDL ELEVATORS

Delicate Arrow tip



4,0mm straight  
4,0mm curved

Luxivators straight  
atraumatic luxation of the tooth



2,5mm straight  
3,5mm straight  
4,5mm straight

Luxivators curved  
atraumatic luxation of the tooth



2,5mm curved  
3,5mm curved  
4,5mm curved



DE-537  
PDL Elevators  
Set of 8 Pcs



## Our Scalers

Compare our scalers and curettes with the best in the industry and you will immediately recognize we are equal in every way but one... price. Note the deep precision knurling for better tactile feel. The same high-grade stainless steel tips, the same light weight (under 18 grams) for less hand fatigue, the same professional craftsmanship, and surpassing the highest industry standards. Of course, any manufacturer can make these claims, but we guarantee and certify ours.

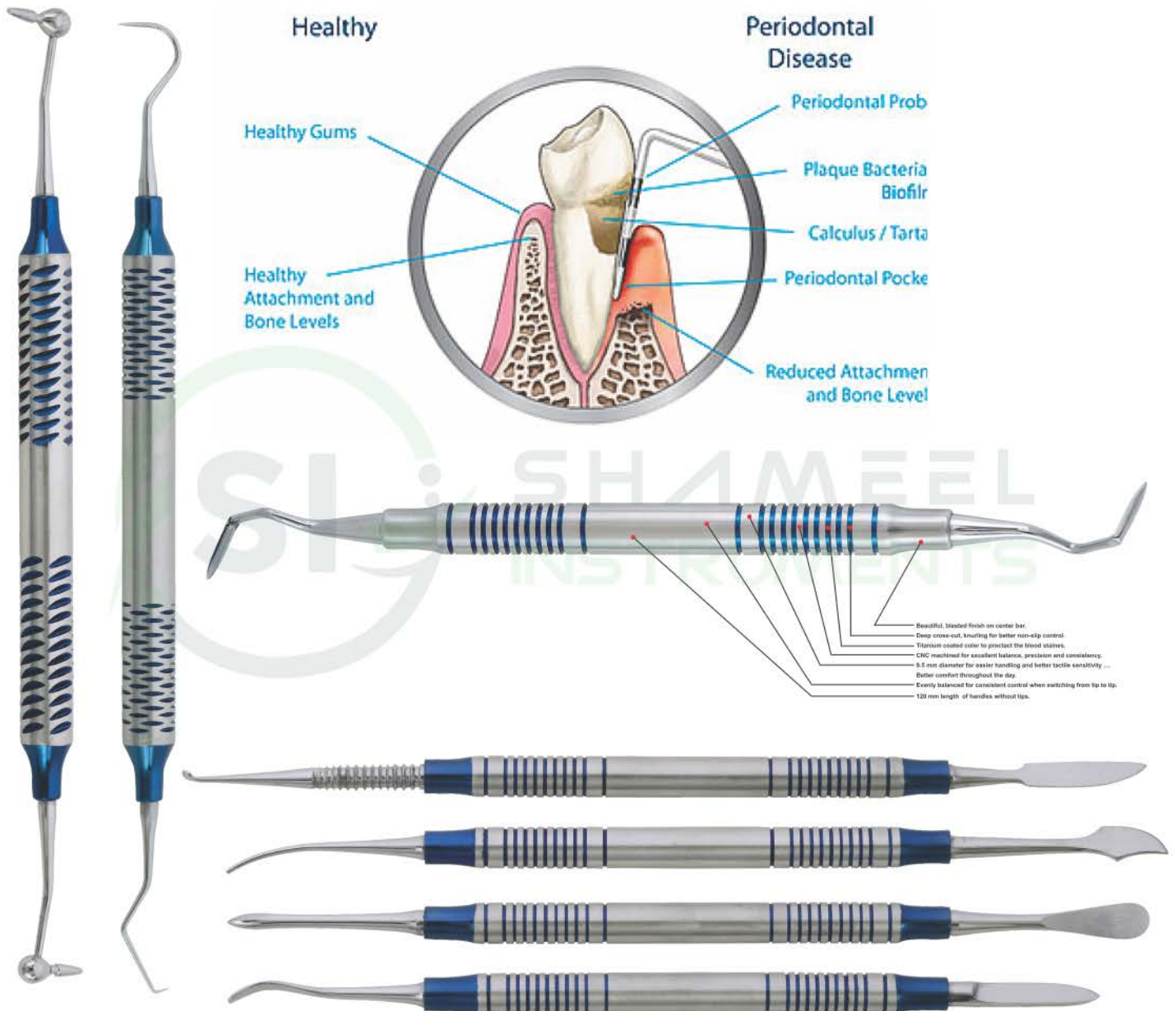

- High-polish mirror finish tips.
- Manufactured within the guidelines of the FDA quality assurance system for good manufacturing practices.
- Highest grade German stainless steel, razor sharp, durable tips. Rockwell hardened to 60 RHc.
- 27 of the most popular designs from gracesys to McCalls to columbias, and many european patterns.
- All instruments are guaranteed against defects in material and workmanship.

- All instruments bear the ce mark, emblematic of the european community's highest standards.
- Customer satisfaction guarantee, too!
- Less than 20 grams ... Lightweight for less hand fatigue.
- Manufactured to the most exacting standards so the 50th instrument you buy is exactly like your first.
- You decide ... Why pay more for the same high-quality instruments?



## DIAGNOSTIC, PERIODONTAL & RESTORATIVE INSTRUMENTS

### VALUED BUYERS

Compare our scalers and curettes with the best in the industry and you will immediately recognize we are equal in every way but one... price. Note the deep precision knurling for better tactile feel. The same high-grade stainless steel tips, the same light weight (under 20 grams) for less hand fatigue, the same professional craftsmanship, and surpassing the highest industry standards. Of course, any manufacturer can make these claims, but we guarantee and certify ours. We regularly manufacturing below articles in showing handles & pattern A to L for better grip & perfection. We are also fully equipped & capable to develop these instruments as per your own specific requirements & demands in materials, sizes, shapes and patterns.



A-Hollow Handle Ø 10 mm



B-Hollow Handle Ø 10 mm



C-Hollow Handle Ø 10 mm



D-Hollow Handle Ø 10 mm



E-Hollow Handle Ø 10 mm



F-Hollow Handle Ø 10 mm



G-Hollow Handle Ø 10 mm



H-Hollow Handle Ø 6.4 mm



I-Hollow Handle Ø 8 mm



J-Hollow Handle Ø 10 mm



K-Soild Handle Ø 6 mm



L-Soild Handle Ø 6 mm



# MOUTH MIRRORS



- зеркала
- Espejos de la boca
- Mundspiegel
- дзеркала
- Miroirs à la bouche
- مرايا الفم

## Plain



**DE-600** Fig. 3 Ø20mm  
**DE-601** Fig. 4 Ø22mm  
**DE-602** Fig. 5 Ø24mm  
**DE-603** Fig. 6 Ø26mm



## Cone-Socket Plain



**DE-604** Fig. 3 Ø20mm  
**DE-605** Fig. 4 Ø22mm  
**DE-606** Fig. 5 Ø24mm

## Magnifying



**DE-607** Fig. 3 Ø20 mm  
**DE-608** Fig. 4 Ø22 mm  
**DE-609** Fig. 5 Ø24 mm



## Cone-Socket Magnifying



**DE-610** Fig. 3 Ø20mm  
**DE-611** Fig. 4 Ø22mm  
**DE-612** Fig. 5 Ø24mm

## Rhodium



**DE-613** Fig. 3 Ø20mm  
**DE-614** Fig. 4 Ø22mm  
**DE-615** Fig. 5 Ø24 mm



## Cone-Socket Rhodium



**DE-616** Fig. 3 Ø20mm  
**DE-617** Fig. 4 Ø22mm  
**DE-618** Fig. 5 Ø24mm

## Front Surface



**DE-619** Fig. 3 Ø20mm  
**DE-620** Fig. 4 Ø22mm  
**DE-621** Fig. 5 Ø24mm  
**DE-622** Fig. 6 Ø26mm



## Cone-Socket Front Surface



**DE-623** Fig. 3 Ø20mm  
**DE-624** Fig. 4 Ø22mm  
**DE-625** Fig. 5 Ø24mm





## HANDLES FOR MOUTH MIRRORS

- Ручки для зеркал
- Manches pour miroirs à bouche
- Mundspiegelgriffe
- Ручки для дзеркал
- Mangos para espejos de boca
- مقابض لمرآيا الفم



**DE-626**  
Hollow Mirror  
Handle Round  
Ø 10 mm



**DE-627**  
Hollow Mirror  
Hexagonal  
Handle  
Ø 8 mm



**DE-628**  
Hollow  
Ø 8 mm



**DE-629**  
Hollow Mirror  
Hexagonal  
Handle  
Ø 10 mm



**DE-630**  
Hollow Mirror  
Handle  
Ø 8 mm



**DE-631**  
Hollow Mirror  
Handle  
Ø 10 mm



**DE-632**  
Mirror Handle  
Solid  
Ø 6 mm



**DE-633**  
Mirror Handle  
Solid  
Ø 6 mm



**DE-634**  
Mirror Handle  
Solid Octagonal  
Ø 6 mm



**DE-635**  
Mirror Handle  
Stem  
with Rule  
35mm



**DE-636**  
Mirror Handle  
Solid  
Stem with  
Rule 35mm



**DE-637**  
Cone-Socket  
Solid Octagonal  
Ø 6 mm



**DE-638**  
Cone-socket  
Solid  
Ø 6 mm



**DE-639**  
Cone-socket  
Hexagonal  
Handle  
Ø 6 mm

Cone-Socket Mirror Handle

# EXPLORERS



- Зонды
  - Sondes
  - Zahnsonden
- Зонди
  - Sondas
  - المستكشفين

Examination kit Set of 3 Pieces



DE-640  
Probe

DE-641  
Mirror

DE-642  
College Forcep  
15cm



Examination Set of 4 Pieces



DE-643  
Exp,23/17-A

DE-644  
Excavators

DE-645  
Tweezers

DE-646  
Mouth Mirror

DE-647

First Aid Examination Set of 3 Pieces



DE-648

First Aid Examination Set of 3 Pieces



DE-649

First Aid Examination Set of 3 Pieces



DE-650

First Aid Examination Set of 3 Pieces





## TWEEZERS

- Пинцеты
- Précelles - Brucelles
- Zahnpinzetten

- Пинцети
- Pinzas para algodón
- ملاقط



**DE-651**  
Surgical  
11.5cm



**DE-652**  
London College  
15cm



**DE-653**  
Semken Taylor  
Str.



**DE-654**  
Semken Taylor  
Cvd.



**DE-655**  
Meriam  
16cm



**DE-656**  
Dressing  
14cm



**DE-657**  
Semken Taylor  
1x2 Straight



**DE-658**  
Semken Taylor  
1x2 Curved



**DE-659**  
Gilles  
15cm 1x2



**DE-660**  
14cm 1x2



**DE-661**  
Perry  
13cm



**DE-662**  
Atraumatic  
15cm Cvd



**DE-663**  
Atraumatic  
15cm Str.



**DE-664**  
College with Lock  
15cm Cvd.



**DE-665**  
Gerald  
17.5cm



**DE-666**  
with lock  
15cm



**DE-667**  
Atraumatic  
17.5cm



# TWEEZERS



- Пинцеты
- Précettes - Brucelles
- Zahnpinzetten

- Пинцети
- Pinzas para algodón
- ملاقط



**DE-668**  
Adson-TC  
12cm



**DE-669**  
Adson-TC  
12cm 1x2



**DE-670**  
Adson-TC  
15cm 1x2



**DE-671**  
Adson  
12cm



**DE-672**  
Adson  
12cm 1x2



**DE-673**  
Adson  
15cm 1x2



**DE-674**  
Adson Brown  
12cm



**DE-675**  
Crane Kaplan  
15cm



**DE-676**  
Crane Kaplan  
15cm



**DE-677**  
Crane Kaplan  
15cm



**DE-678**  
Hemingway  
15cm



**DE-679**  
Miller  
15cm Str.



**DE-680**  
Miller  
15cm Cvd.



**DE-681**  
Dressing  
Tweezer  
14.5cm



**DE-682**  
College  
Curved  
Tip  
15cm



**DE-683**  
Maryam  
Tweezers  
15cm



**DE-684**  
College  
Tweezer  
15cm



**DE-685**  
Perry  
Tweezer  
12.5cm



**DE-686**  
Self-locking  
Tweezer  
15cm



# EXPLORERS

- Зонды
- Sondes
- Zahnsonden
- Зонди
- Sondas
- المستكشفين

Single Ended Probe Solid Handle 4.5mm Length 150mm



Explorers-Single-End

Double-Ended Explorers

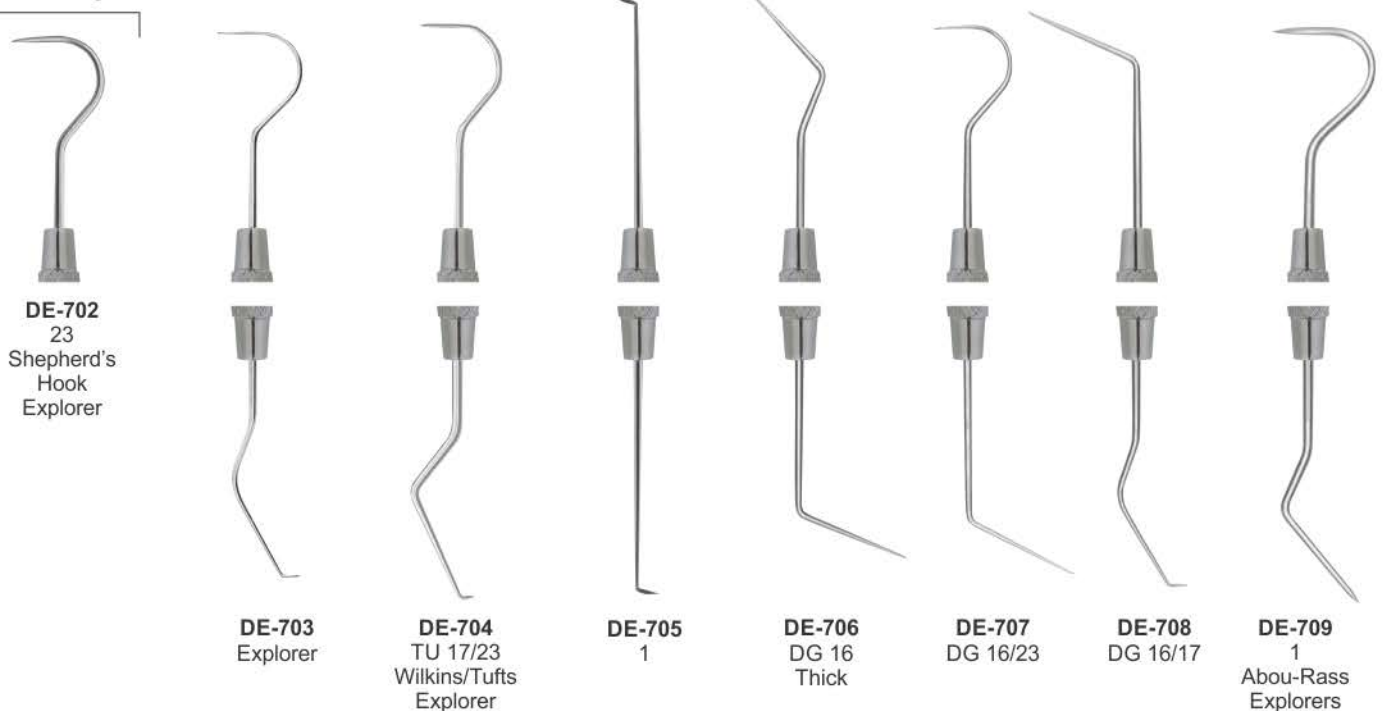

# EXPLORERS



- Зонды
  - Sondes
  - Zahnsonden
- Зонди
  - Sondas
  - المستكشفين

Probes Double Ended 6mm, length 170mm

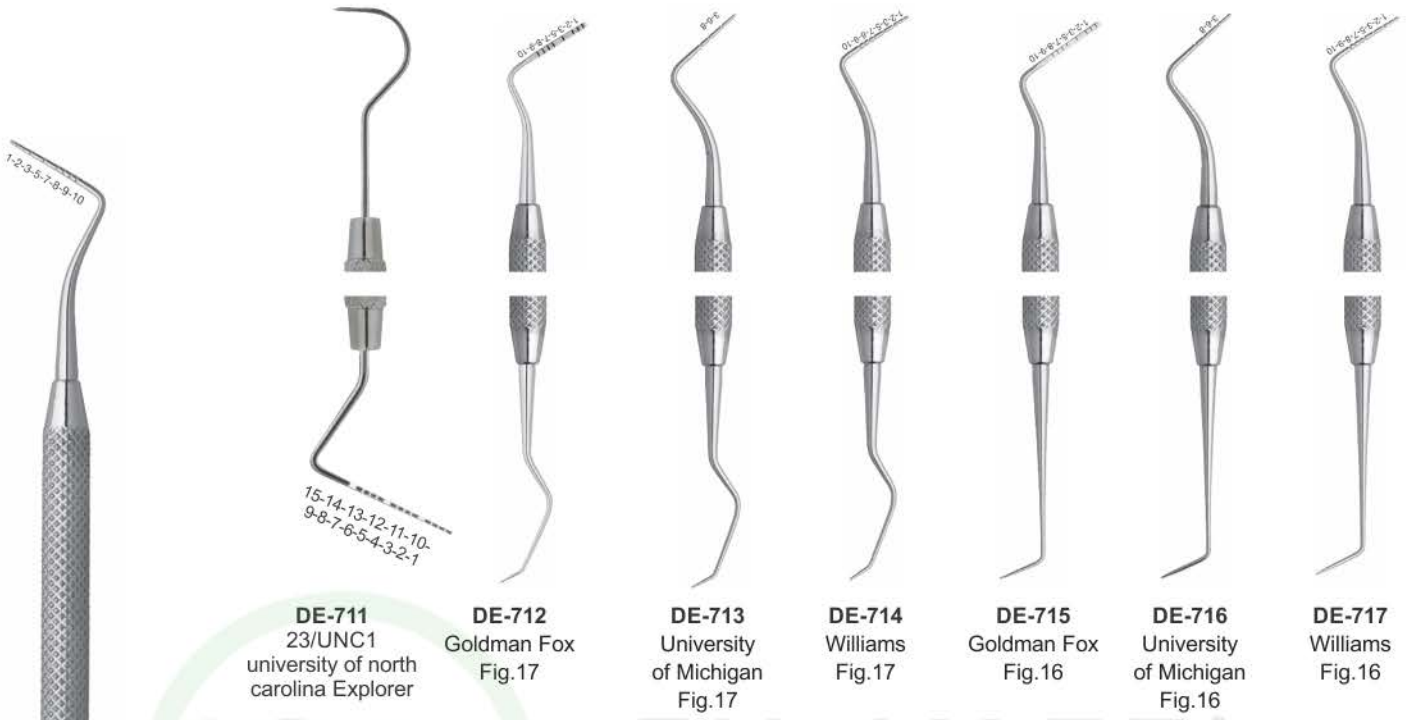

**DE-711**  
23/UNC1  
university of north carolina Explorer

**DE-712**  
Goldman Fox  
Fig.17

**DE-713**  
University of Michigan  
Fig.17

**DE-714**  
Williams  
Fig.17

**DE-715**  
Goldman Fox  
Fig.16

**DE-716**  
University of Michigan  
Fig.16

**DE-717**  
Williams  
Fig.16

Pointed Probes Double Ended Handle 6mm, length 170mm



**DE-710**  
Williams

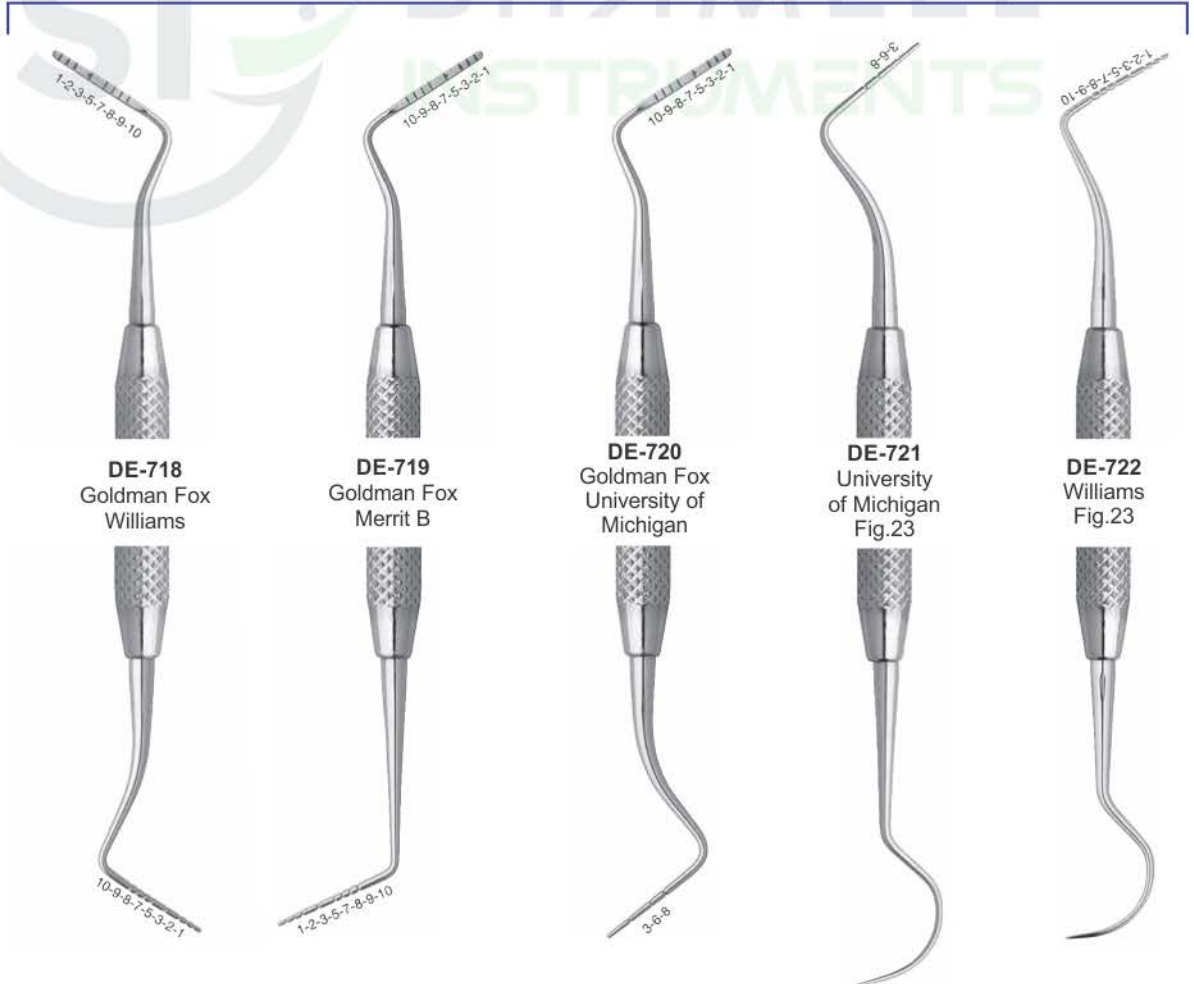

**DE-718**  
Goldman Fox  
Williams

**DE-719**  
Goldman Fox  
Merrit B

**DE-720**  
Goldman Fox  
University of Michigan

**DE-721**  
University of Michigan  
Fig.23

**DE-722**  
Williams  
Fig.23





# EXPLORERS

- Зонды
- Sondes
- Zahnsonden
- Зонди
- Sondas
- المستكشفين

EXPLORERS INSTRUMENTS SOLID HANDLE 6MM, LENGTH 170MM

## PLUGGERS

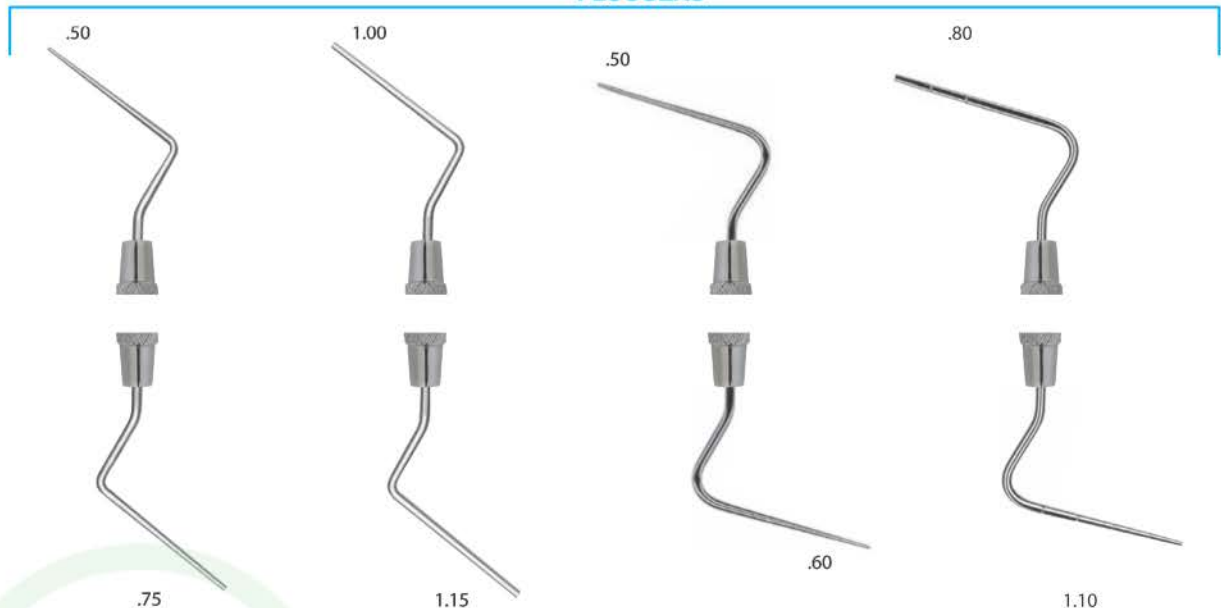

.75  
**DE-724**  
 5/7  
 21mm

1.15  
**DE-725**  
 9/11  
 21mm

**DE-726**  
 1/2  
 Root Canal  
 Plugger

**DE-727**  
 3/4  
 Root Canal  
 Plugger

**DE-723**  
 1/3  
 21mm

**DE-728**  
 MA57  
 27mm

**DE-729**  
 GP3  
 30mm



# PERIODONTAL PROBES



- Зонды пародонтологические
- Sondes paradontales
- sonde parodontall
- зонди пародонтологічні
- Sondas paradontales
- المسابير اللثة

## SPREADERS

## HEAT CARRIERS

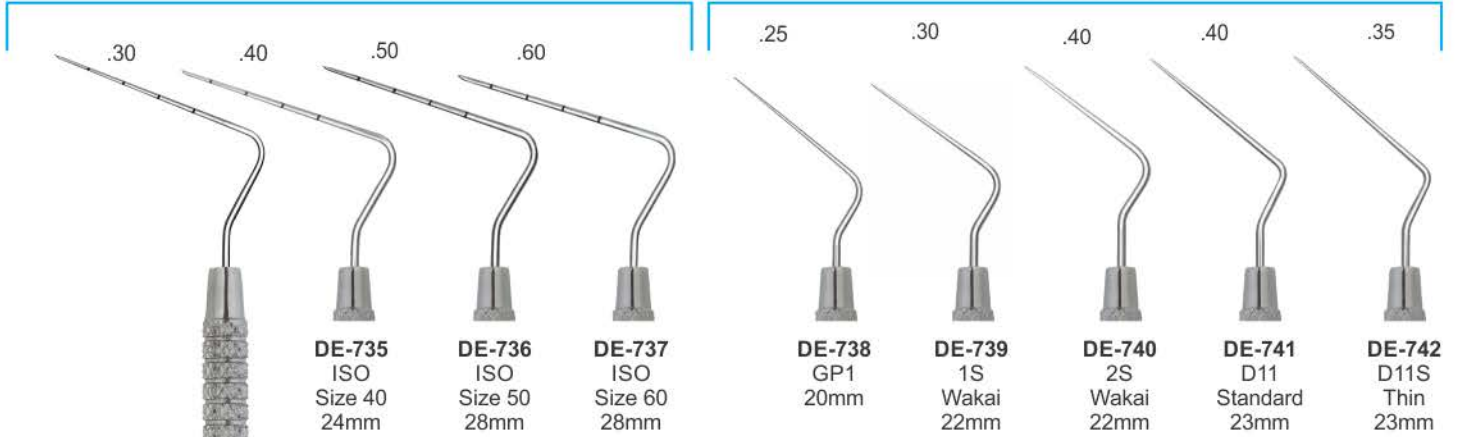

## HEAT CARRIERS

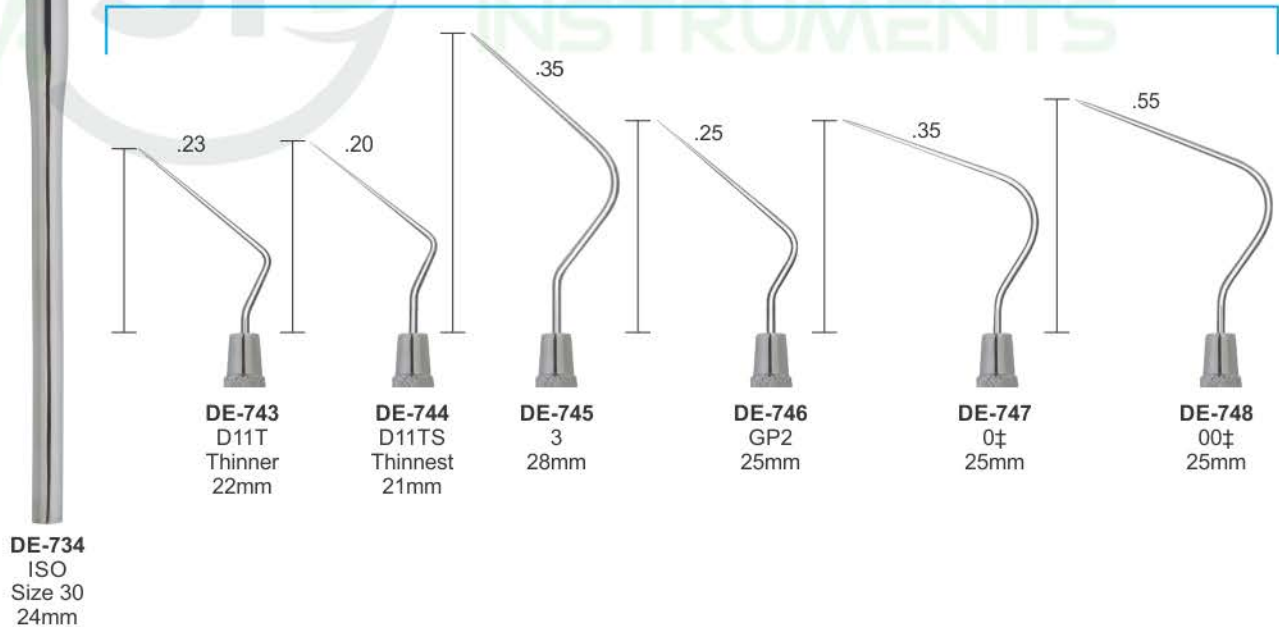



# PERIODONTAL PROBES

- Зонды пародонтологические
- Sondes paradontales
- sonda parodontali
- зонди пародонтологічні
- Sondas paradontales
- المسابر اللثة

## ENDODONTICS INSTRUMENTS

### ANTERIOR



**DE-749**  
8A  
29mm

**DE-750**  
8 1/2A  
29mm

**DE-751**  
9A  
29mm

**DE-752**  
9 1/2A  
29mm

**DE-753**  
10A  
29mm

**DE-754**  
10 1/2A  
29mm

**DE-755**  
11A  
29mm

**DE-756**  
11 1/2A  
29mm

**DE-757**  
12A  
29mm

### LUKS



**DE-758**  
L1  
18mm

**DE-759**  
L2  
18mm

**DE-760**  
L3  
18mm

**DE-761**  
L4  
18mm





DE-762  
Gracey Curettes 1/2



DE-763  
Gracey Curettes 3/4



DE-764  
Gracey Curettes 5/6



DE-765  
Gracey Curettes 7/8



DE-766  
Gracey Curettes 9/10



DE-767  
Gracey Curettes 11/12



DE-768  
Gracey Curettes 13/14



DE-769  
Gracey Curettes 1/2



DE-770  
Gracey Curettes 3/4



DE-771  
Gracey Curettes 5/6



DE-772  
Gracey Curettes 7/8



DE-773  
Gracey Curettes 9/10



DE-774  
Gracey Curettes 11/12



DE-775  
Gracey Curettes 13/14





# SCALER

## GRACEY MINI FIVE

Hollow Handle 9.5mm, Length 170mm Ceramic Coated Handle



**DE-777**  
Fig. 3/4 Gracey 3M



**DE-778**  
Fig. 5/6 Gracey 3M



**DE-779**  
Fig. 7/8 Gracey 3M  
Buccal and lingual/  
Palatal surfaces



**DE-780**  
Fig. 11/12 Gracey 3M  
Mesial



**DE-781**  
Fig. 13/14 Gracey 3M  
Distal

**DE-776**  
Fig. 1/2  
Gracey 3m



## GRACEY AFTER FIVE

Hollow Handle 9.5mm, Length 170mm Ceramic Coated Handle



**DE-783**  
Gracey 3/4 AF



**DE-784**  
Gracey 5/6 AF



**DE-785**  
Gracey 7/8 AF



**DE-786**  
Gracey 11/12 AF



**DE-787**  
Gracey 13/14 AF

**DE-782**  
Gracey  
1/2 AF



Gracey Curettes



$\frac{3...1}{3...1} \mid \frac{1...3}{1...3}$  **DE-788** Fig. 1/2 GR - Gracey  
Buccal surfaces



$\frac{5...1}{5...1} \mid \frac{1...5}{1...5}$  **DE-789** Fig. 3/4 GR - Gracey  
Lingual/Palatal surfaces



$\frac{5...1}{5...1} \mid \frac{1...5}{1...5}$  **DE-790** Fig. 5/6 GR - Gracey



$\frac{8...4}{8...4} \mid \frac{4...8}{4...8}$  **DE-791** Fig. 7/8 GR - Gracey  
Buccal and lingual/  
palatal surfaces



$\frac{8...4}{8...4} \mid \frac{4...8}{4...8}$  **DE-792** Fig. 9/10 GR - Gracey  
Buccal and lingual/  
palatal surfaces more angled



$\frac{8...4}{8...4} \mid \frac{4...8}{4...8}$  **DE-793** Fig. 11/12 GR - Gracey  
Mesial



$\frac{8...4}{8...4} \mid \frac{4...8}{4...8}$  **DE-794** Fig. 13/14 GR - Gracey  
Distal



$\frac{8...4}{8...4} \mid \frac{4...8}{4...8}$  **DE-795** Fig. 15/16 GR - Gracey  
Mesial



$\frac{8...4}{8...4} \mid \frac{4...8}{4...8}$  **DE-796** Fig. 17/18 GR - Gracey  
Distal



- # 1/2 - # 3/4 - # 5/6
- # 7/8 - # 9/10
- # 11/12 - # 15/16
- # 13/14 - # 17/18



- # 1/2 - # 3/4 - # 5/6
- # 7/8 - # 9/10
- # 11/12 - # 15/16
- # 13/14 - # 17/18



# SCALER

## Sickle Scalars



DE-797 Fig. U15/33 - Towner-Jaquette



DE-798 Fig. U15/30 - Towner-Jaquette



DE-799 Fig. H5/33



DE-800 Fig. H6/H7



DE-801 Fig. 30/33 - Jaquette



DE-802 Fig. T2/T3 - Taylor



DE-803 Fig. 204



DE-804 Fig. 204S



DE-805 Fig. 11/12 - MC - McCall  
Mesial



DE-806 Fig. 13/14 - MC - McCall  
Distal



**Straight and curved sickle scalars**  
Feature: 2 cutting edges curved facial component tipped ends

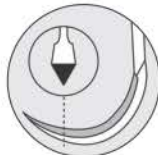

**Universal curettes**  
are characterized by an angle of 90° between the terminal stem and the cutting component.

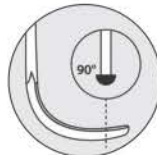

**Gracey curettes**  
are characterized by an angle of 70° between the terminal stem and the cutting component.

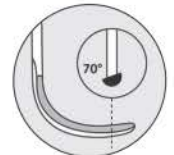

Universal Curettes



DE-807 Fig. 13S/14S - MC - McCall



DE-808 Fig. 17S/18S - MC - McCall  
Distal



DE-809 Fig. M23



DE-810 Fig. 204SD



DE-811 Fig. YG7/8-Younger Good



DE-812 Fig. L 1/2 - Langer



DE-813 Fig. L 3/4 - Langer



DE-814 Fig. L 5/6 - Langer



DE-815 Fig. M 23A



DE-816 Fig. M 23B

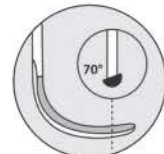
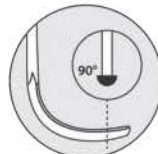
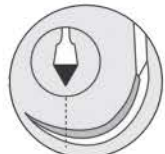
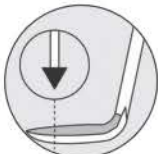

**Straight and curved sickle scalers**  
Feature: 2 cutting edges curved facial component tipped ends

**Universal curettes**  
are characterized by an angle of 90° between the terminal stem and the cutting component.

**Gracey curettes**  
are characterized by an angle of 70° between the terminal stem and the cutting component.

Periodontal knives







Chisels  
Diamond coated margin trimmers

Thanks to the diamond-coated hand instruments the margins are evenly levelled.



## SCALER

### Margin trimmers



**DE-835**  
1TH2 Hirt



**DE-836**  
5TH6 Hirt



**DE-837**  
3TH4 Hirt



**DE-838**  
7TH8 Hirt



**DE-839**  
62NS61

2.0 MM



**DE-840**  
37NS36

1.5 MM



**DE-841**  
66NS65

1.0 MM



**DE-842**  
79CI180 Black



**DE-843**  
77CI78 Black



**DE-844**  
279CI280 Black



**DE-845**  
277CI278 Black



**DE-846**  
179CI180 Black



**DE-847**  
177CI178 Black

CHISELS



DE-848  
1/2 Werdelstaedt



DE-849  
3/4 Werdelstaedt



DE-850  
7 Straight



DE-851  
5/6 Straight



DE-852  
7/10 Straight



DE-853  
8/9 Binangle



DE-854  
11/12 Binangle



DE-855  
40/41 Binangle

Tartar Remover Instruments Solid Handle Ø 6 mm



DE-856  
Fig. 1



DE-857  
Fig. 1L  
Left

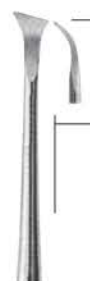

DE-858  
Fig. 1R  
Right



DE-859  
Fig. 2L  
left



DE-860  
Fig. 2R  
Right



DE-861



DE-862



DE-863





## BURNISHERS CONSERVATIVE TREATMENT



**DE-864**  
WHITE 28



**DE-865**  
WHITE 29



**DE-866**  
WHITE 31



**DE-867**  
WHITE 32



**DE-868**  
WHITE 33



**DE-869**  
WHITE 34



**DE-870**  
WESTCOTT 21



**DE-871**  
WESTCOTT 21B



**DE-872**



**DE-873**



**DE-874**  
WHITE



**DE-875**  
WHITE



DE-876



DE-877



DE-878



DE-879



DE-880



DE-881



DE-882



DE-883



DE-884



DE-885  
PLANATOR



DE-886  
PLANATOR



# FILLING INSTRUMENTS CONSERVATIVE TREATMENT

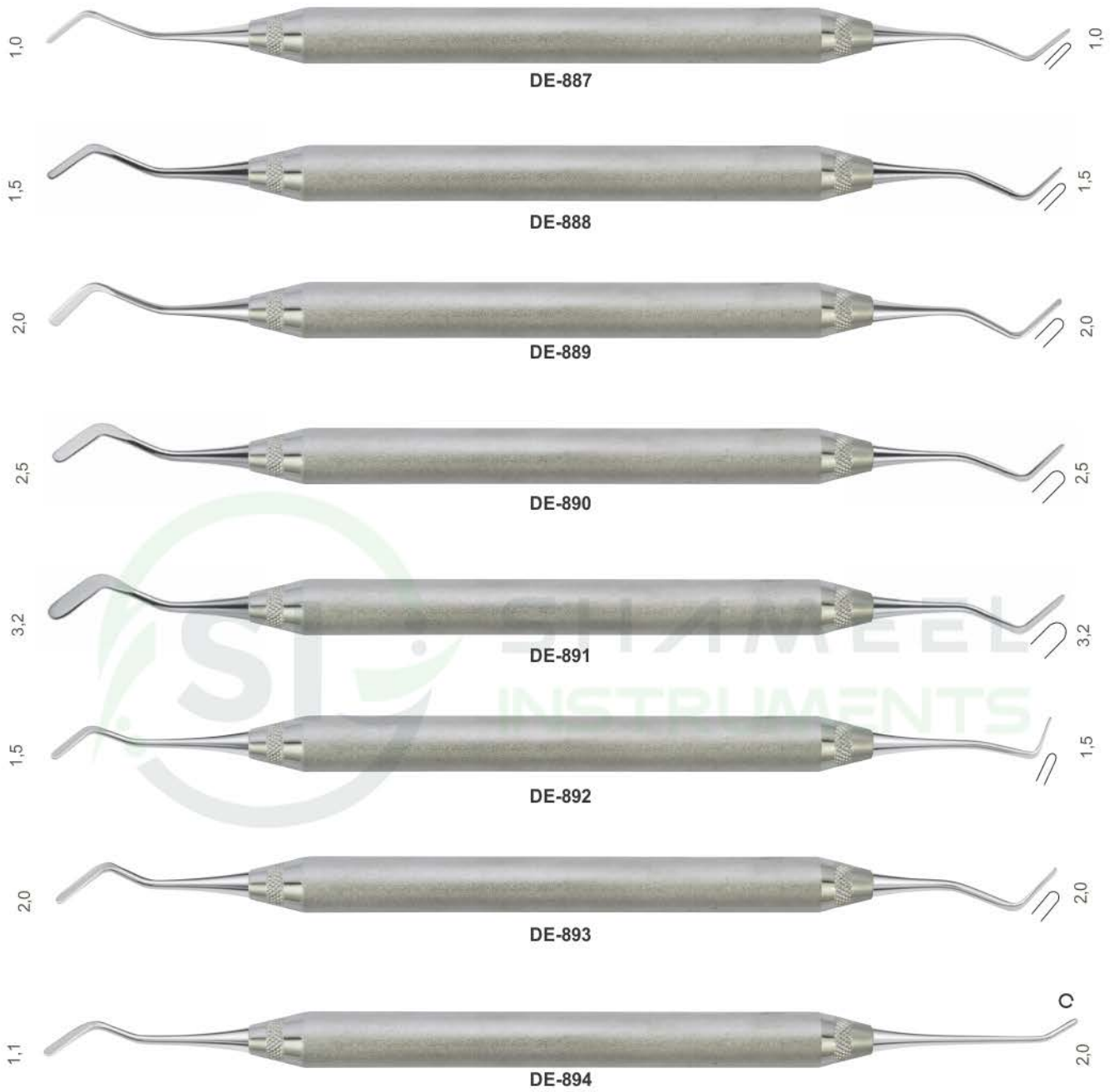



Ball Burnishers



DE-895



DE-896



DE-897



DE-898



Hatches



DE-899



DE-900



DE-901  
Mini-Spatel



DE-902  
Mini-Spatel



# COMPOSITE INSTRUMENTS

Spatulas rounded and sharp

1.5 MM



DE-903  
CPRO4C

1.5 MM



DE-904  
CPRO5C

1.5 MM



DE-905  
TH66C Hirt

1.5 MM

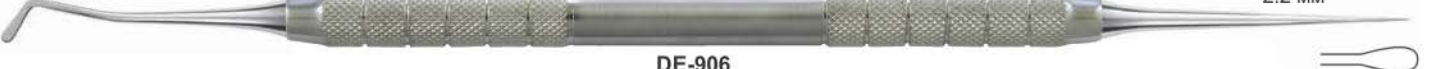

DE-906  
MB5C Besek



Spatulas Blade Thickness 0.22 MM

1.6 mm Approximal



DE-907  
MB4C Besek

1.0 MM



DE-908  
OP551C

1.6 MM



DE-909  
OP55C

1.5 MM

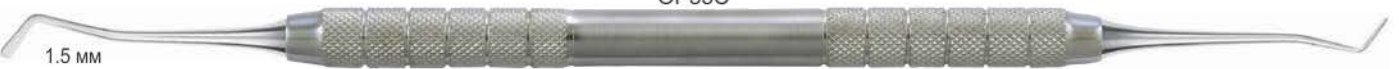

DE-910  
ZI66C

1.6 MM



DE-911  
OP33DC

1.8 MM



DE-912  
OP3DC

2.6 MM



DE-913  
OP26C

3.0 MM



DE-914  
OP22C

2.5 MM



DE-915  
ZI62C



## Spatulas



## Spatulas-Pluggers







## EXCAVATOR INSTRUMENTS

Water drop Our excavators have particularly sharp blades, free of burrs and perfectly rounded.

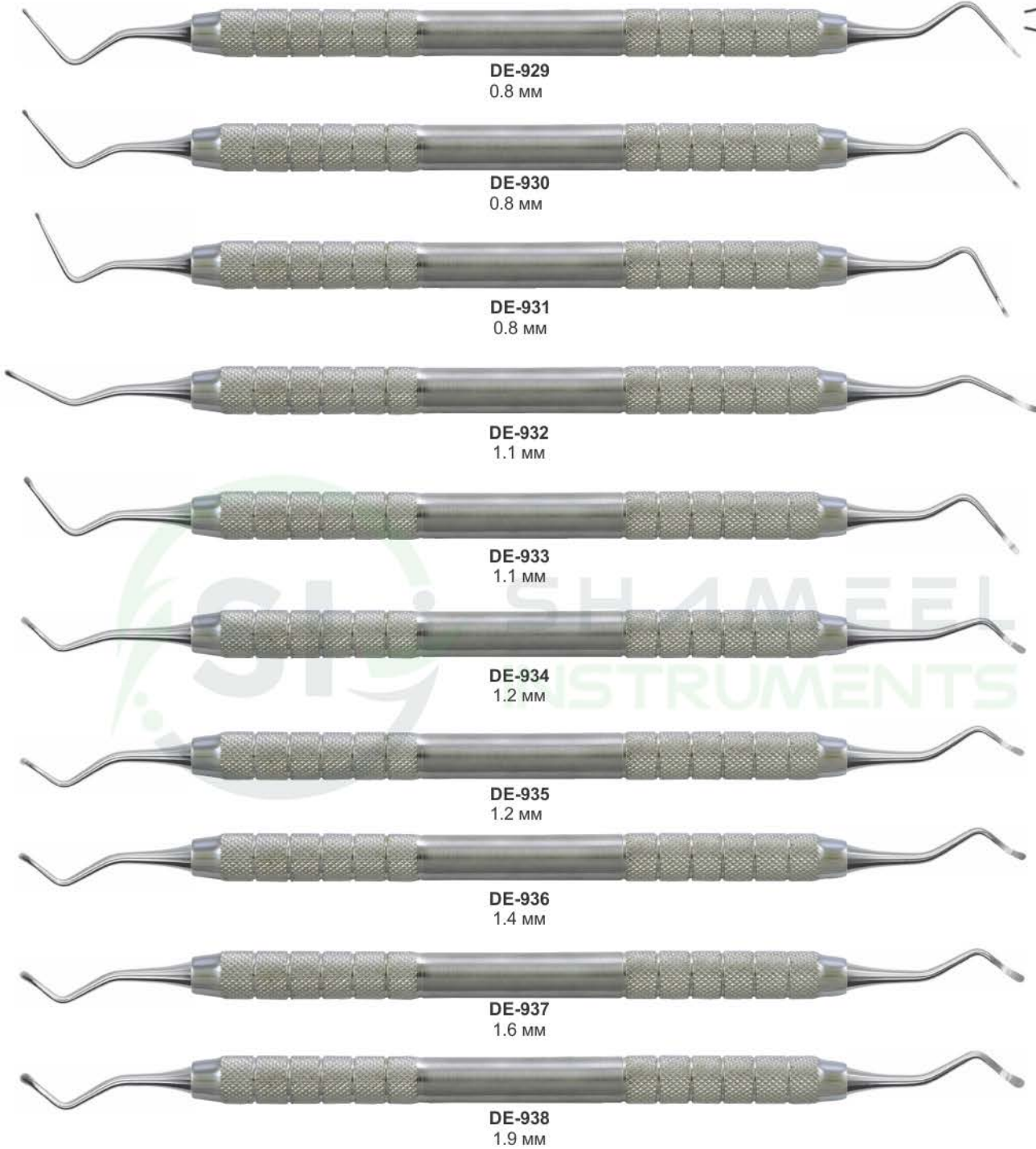







## COMPOSITE BALL PLUGGERS

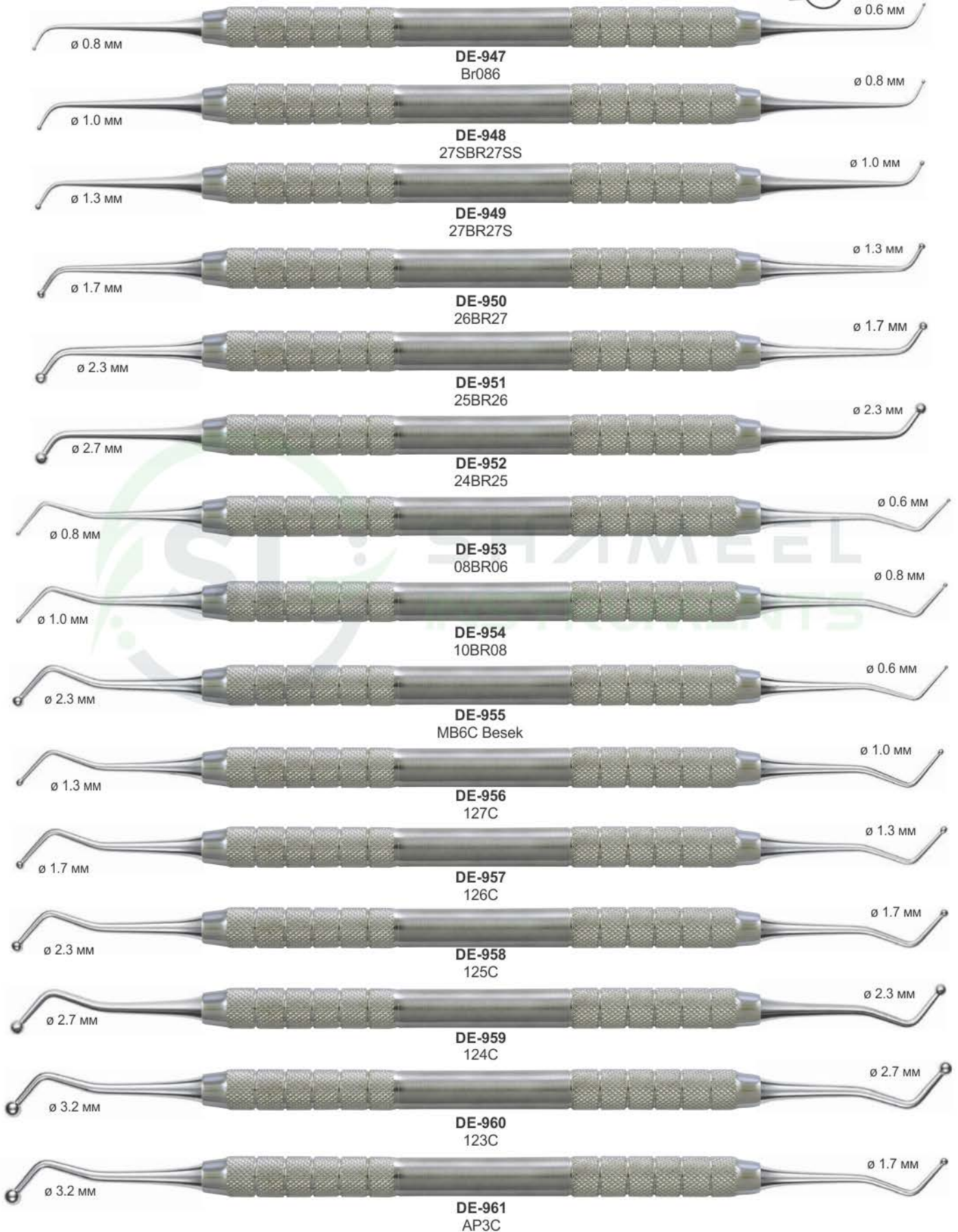



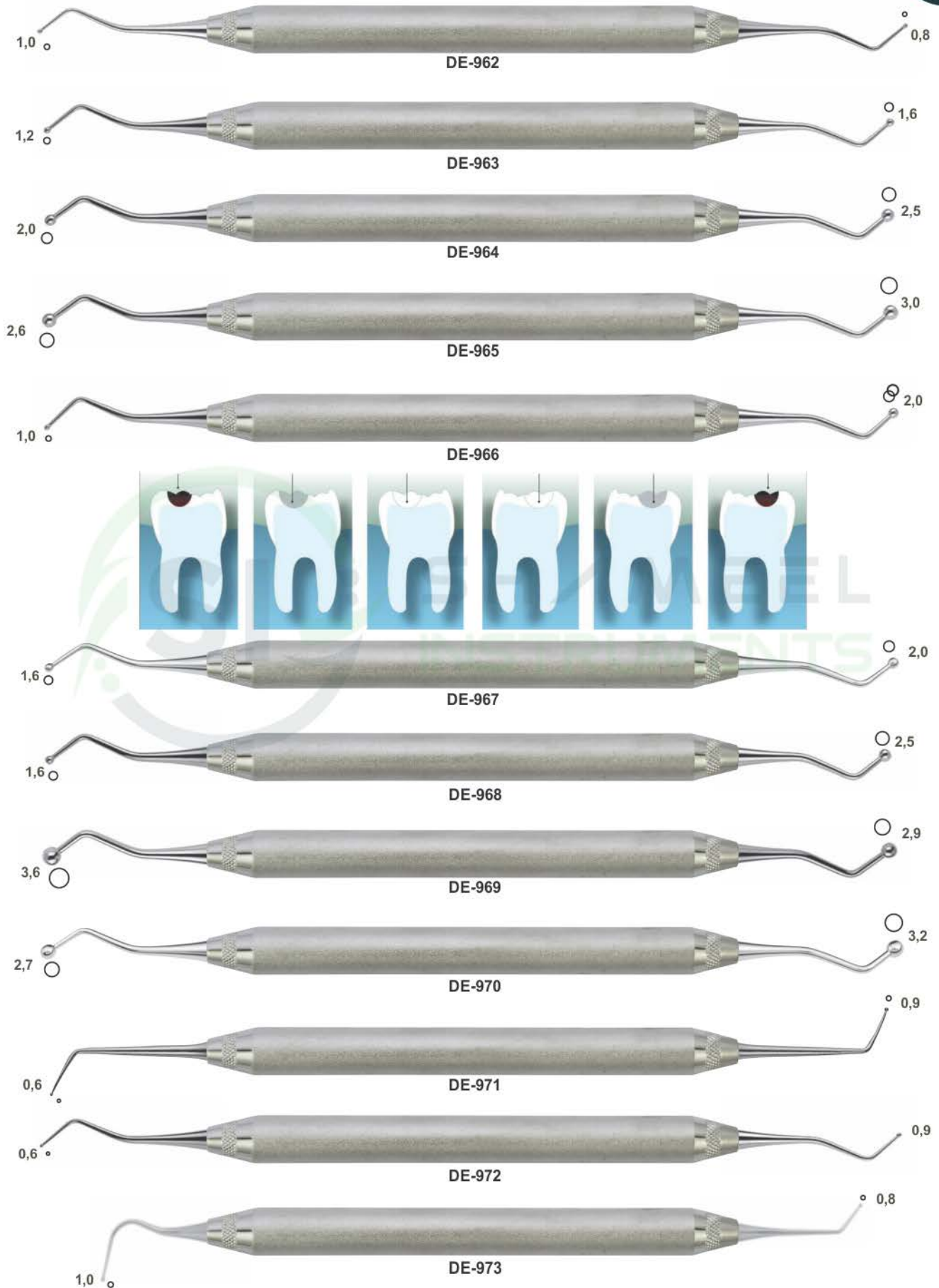



# FILLING INSTRUMENTS CONSERVATIVE TREATMENT



# FILLING INSTRUMENTS CONSERVATIVE TREATMENT







## FILLING INSTRUMENTS CONSERVATIVE TREATMENT





DE-1005  
WILLIAMS



DE-1006  
WILLIAMS



DE-1007  
WILLIAMS



DE-1008



DE-1009



DE-1010



DE-1011



DE-1012



DE-1013



DE-1014



## COMPOSITE PLUGGERS INSTRUMENTS

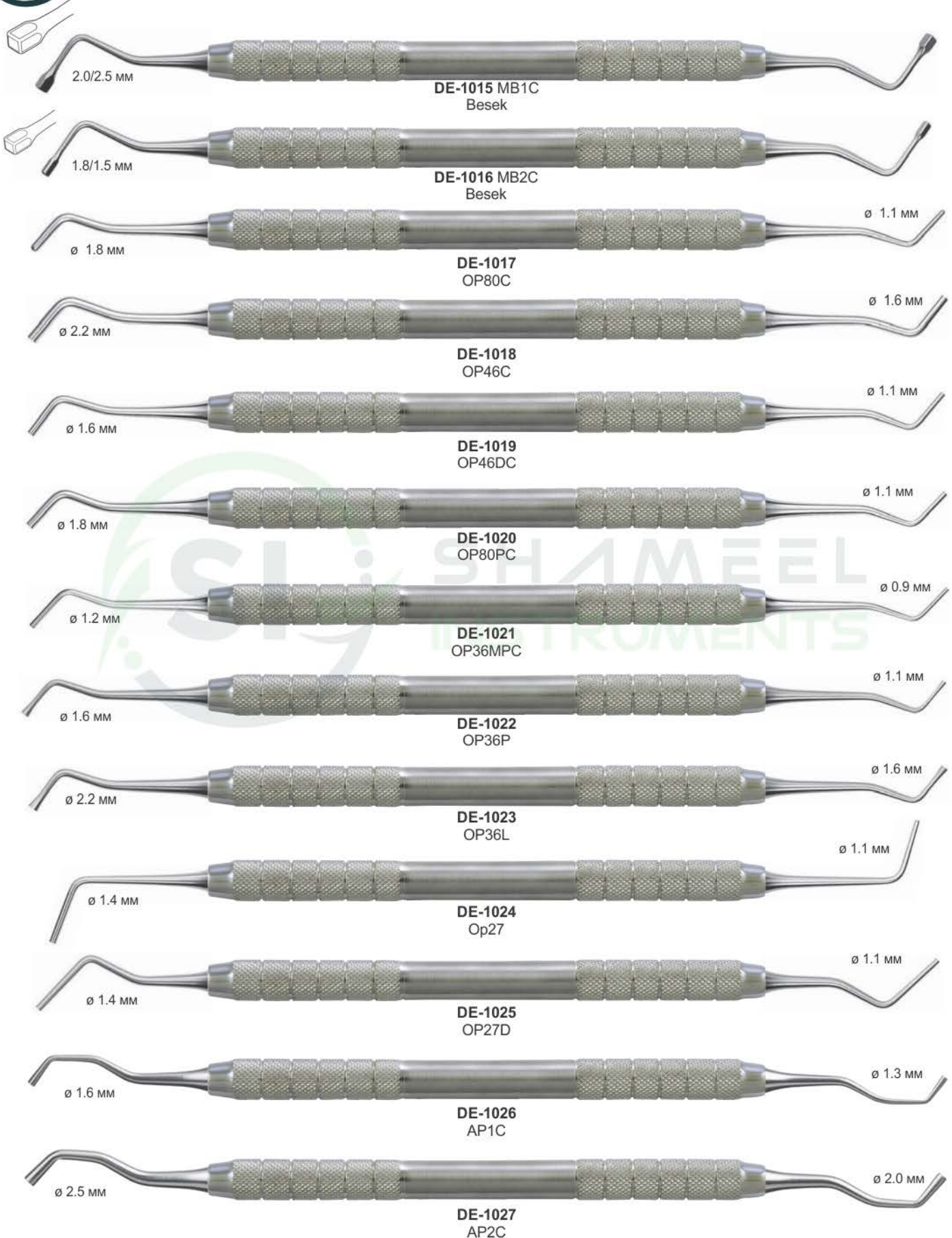







# FILLING INSTRUMENTS CONSERVATIVE TREATMENT

## Serrated Pluggers



Instrument	Tip Diameter
DE-1034 OP36M	Ø 1.2 MM
DE-1035 OP36D	Ø 1.6 MM
DE-1036 Op36	Ø 2.2 MM
DE-1037 Op52	Ø 1.7 MM
DE-1038 Zi51	Ø 2.6 MM
DE-1039 Op44	Ø 2.2 MM
DE-1040 1BR2	Ø 2.6 MM
DE-1041 2BR3	Ø 3.6 MM







DE-1042 MF2C  
Fuzzi



DE-1043  
Pj4



DE-1044 MB3C  
Besek



DE-1045  
HZ3C



DE-1046  
CPRO3C



DE-1047 Mo1  
Monari



DE-1048 TH28C  
Hirt



DE-1049  
HZ25C



DE-1050  
Ck10



DE-1051  
CK28BC



DE-1052 Op37  
Carver



DE-1053  
28BR29



## Round excavators

### Cariology

- for the removal of softened, carious dentin
- for the removal of temporary fillings

### Surgery

- to sever the periodontal ligament prior to extraction
- for the removal of granulation tissue after extraction

Design: Round working end Curved cutting edge



Round Excavator, 1.0 mm  
DE-1054



Round Excavator, 1.5 mm  
DE-1055



Round Excavator, 2.0 mm  
DE-1056

## Triple-angled back action excavators



Triple-angled Back Action Excavator, 1.0 mm  
DE-1057



Triple-angled Back Action Excavator, 1.5 mm  
DE-1058



Triple-angled Back Action Excavator, 2.0 mm  
DE-1059



Triple-angled Back Action Excavator, 3.5 mm  
DE-1060

# FILLING INSTRUMENTS



- Инструменты для реставрации
- Instruments pour plombage
- Füllungsinstrumente (mit Kontrawinkel)
- Інструменти для реставрації
- Instrumentos para obturaciones
- ملء الصكوك

COMPOSITE/PLASTIC FILLING INSTRUMENTS SOLID HANDLE 6MM, LENGTH 170MM

BLACK

PLUGGERS/CONDENSERS

Hollenback

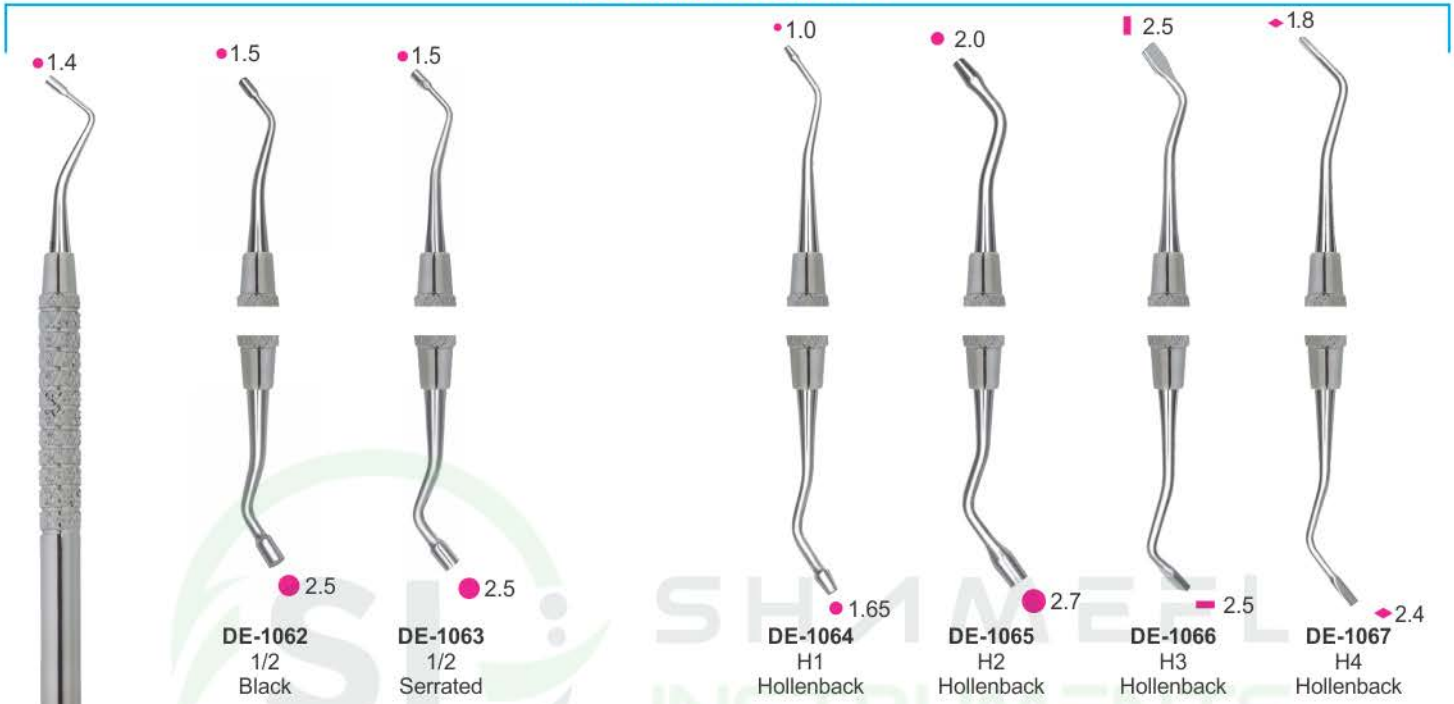

MARQUETTE CONDENSER

MORTONSON

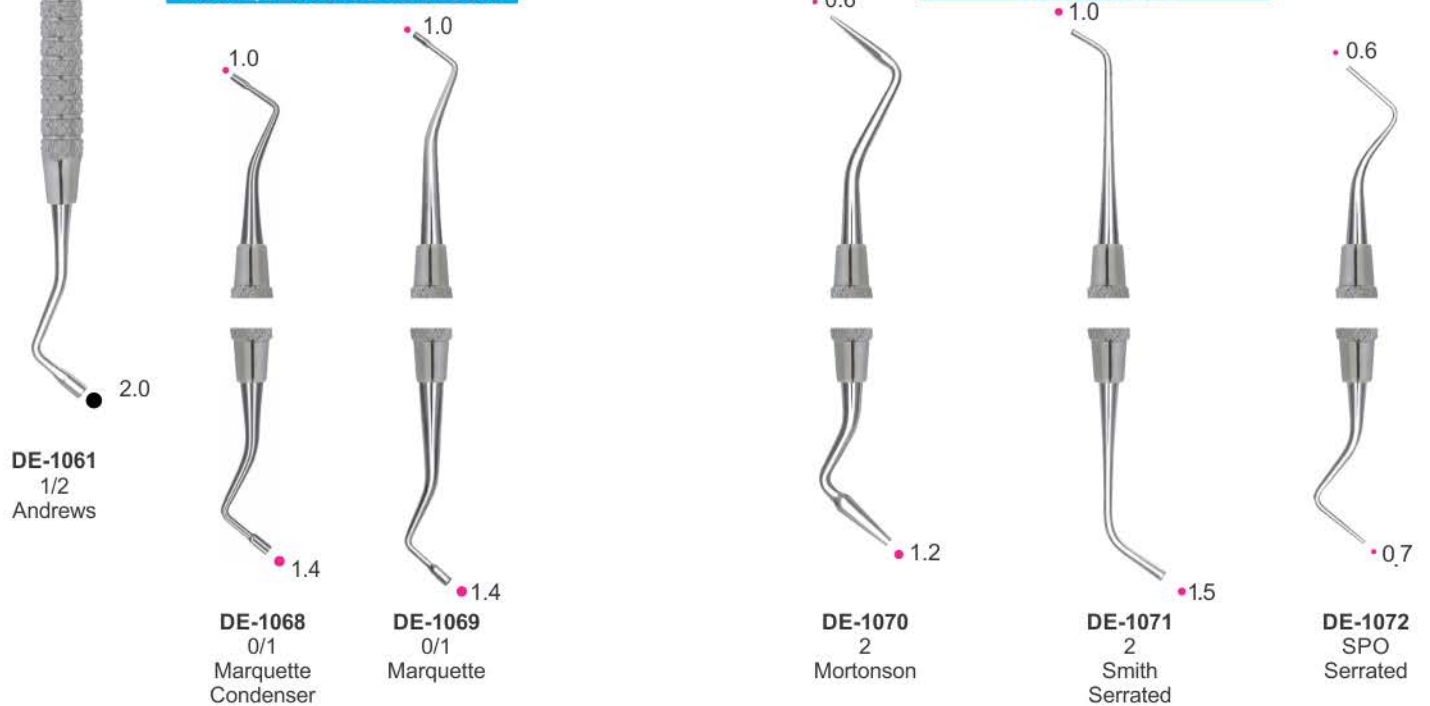



# FILLING INSTRUMENTS

- Инструменты для реставрации
- Instruments pour plombage
- Füllungsinstrumente (mit Kontrawinkel)
- Инструменти для реставрації
- Instrumentos para obturaciones
- ملء الصكوك

## RESTORATIVE INSTRUMENTS SOLID HANDLE 6MM, LENGTH 170MM Back Action Filling Instruments

### Tanner Filling Instruments

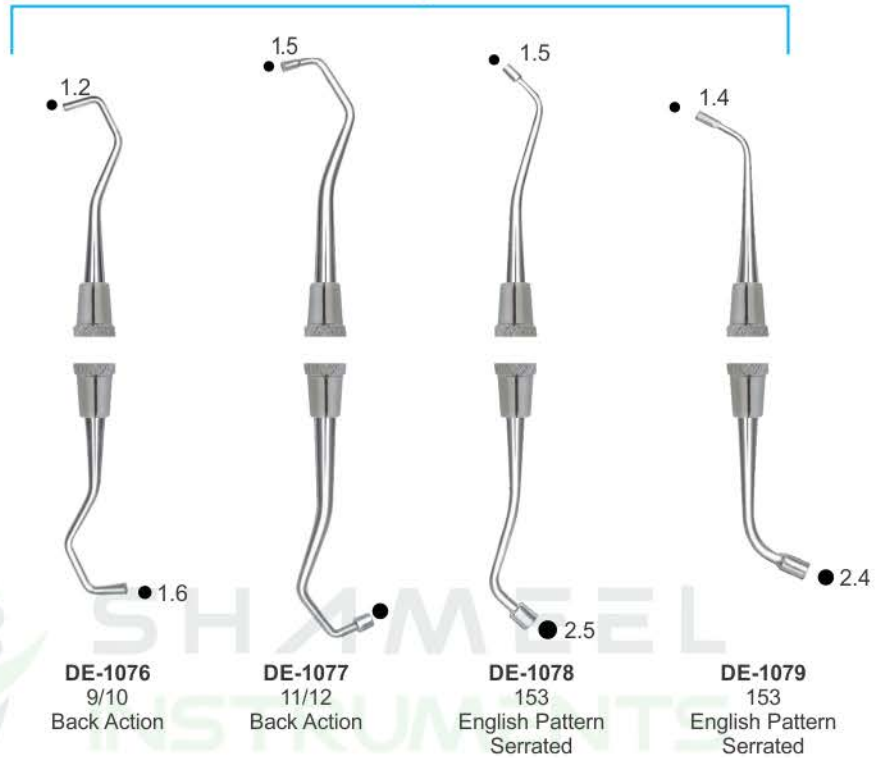

### BALL

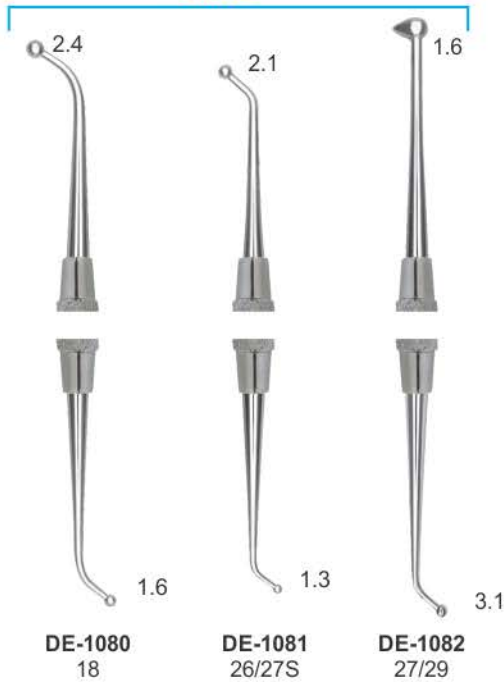

### BURNISHERS

### BEAVERTAIL



### ACORN



### LADMORE





# CARVERS INSTRUMENTS



- Инструменты для реставрации
- Instruments a modeler
- Modellierinstrumente

- Инструменти для реставрації
- Instrumentos para modelar
- ادوات تقطیع

## P.K. THOMS WAXING INSTRUMENTS SOLID HANDLE 6mm



DE-1095  
Composite Instruments Blue  
Titanium with Cassettes



DE-1094  
P.k. Thomas Waxing Instruments Kit

## COMPOSITE INSTRUMENTS TITANIUM BLUE ENDODONTIC

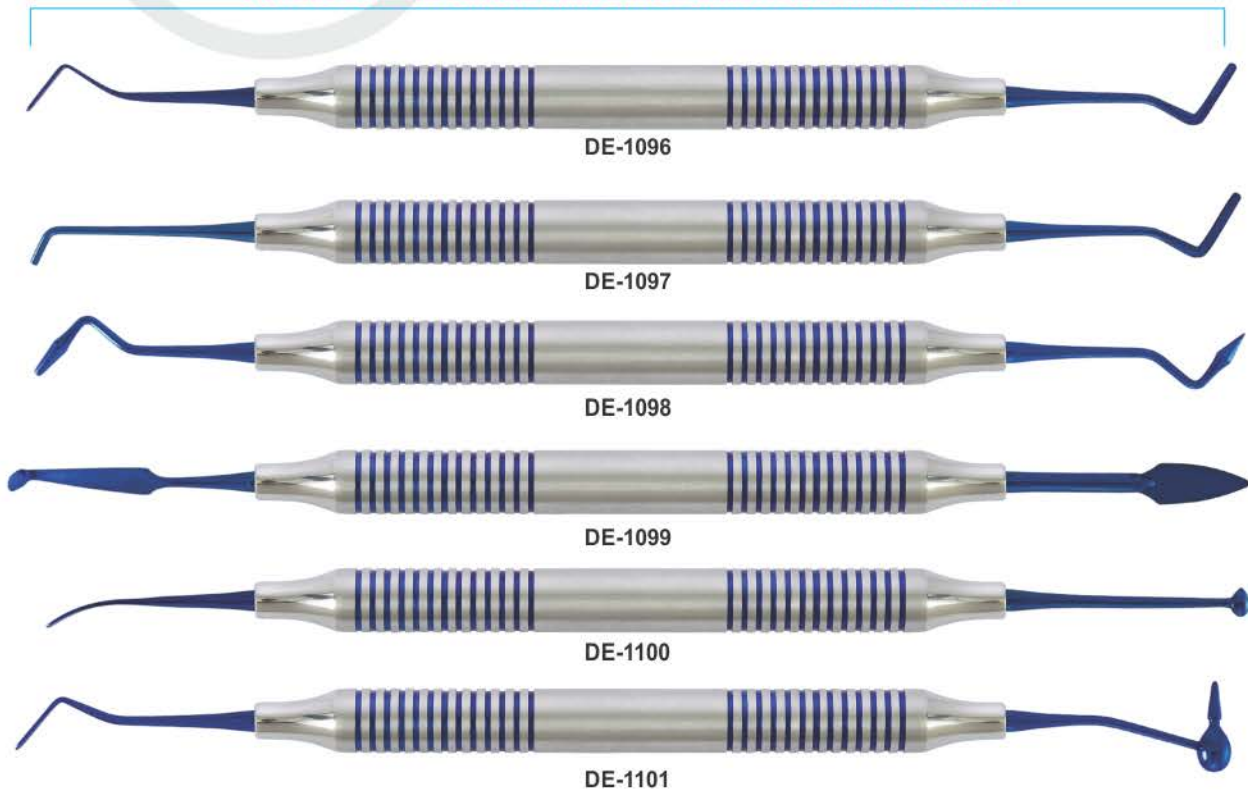



## CARVERS INSTRUMENTS

- Инструменты для реставрации
- Instruments a modeler
- Modellierinstrumente
- Инструменти для реставрації
- Instrumentos para modelar
- أدوات تقطیع



DE-1102



DE-1103



DE-1104



DE-1105



DE-1106



Cassette For 5 Instruments  
DE-1107

# FILLING INSTRUMENTS



- Инструменты для реставрации
- Instruments pour plombage
- Füllungsinstrumente (mit Kontrawinkel)
- Инструменти для реставрації
- Instrumentos para obturaciones
- ملء الصكوك

## FILLING INSTRUMENTS (Gold Pointed) SOLID HANDLE 6MM, LENGTH 170MM



DE-1108 1.5mm / 1.5mm

DE-1109 2.0mm / 2.0mm

DE-1110 2.0mm / 2.0mm

DE-1111 2.5mm / 2.5mm

DE-1112 1.3mm / 0.9mm

DE-1113 1.6mm / 1.3mm

DE-1114 2.4mm / 1.8mm

DE-1115 2.4mm / 2.0mm

DE-1116 1.3mm / 1.5mm

DE-1117 1.8mm / 1.2mm

Filling instrument, spatula 6 mm solid handle, length 170 mm,

Filling instrument 6 mm length 175 mm,

Filling instrument, ball 6 mm length 170 mm,

Filling instrument, ball / spatula 6 mm length 175 mm,

Filling instrument, plan / plan 6 mm length 165 mm,





## COMPOSITE FILLING INSTRUMENTS

- Инструменты для реставрации
- Instruments pour plombage
- Füllungsinstrumente (mit Kontrawinkel)
- Інструменти для реставрації
- Instrumentos para obturaciones
- ملء الصكوك

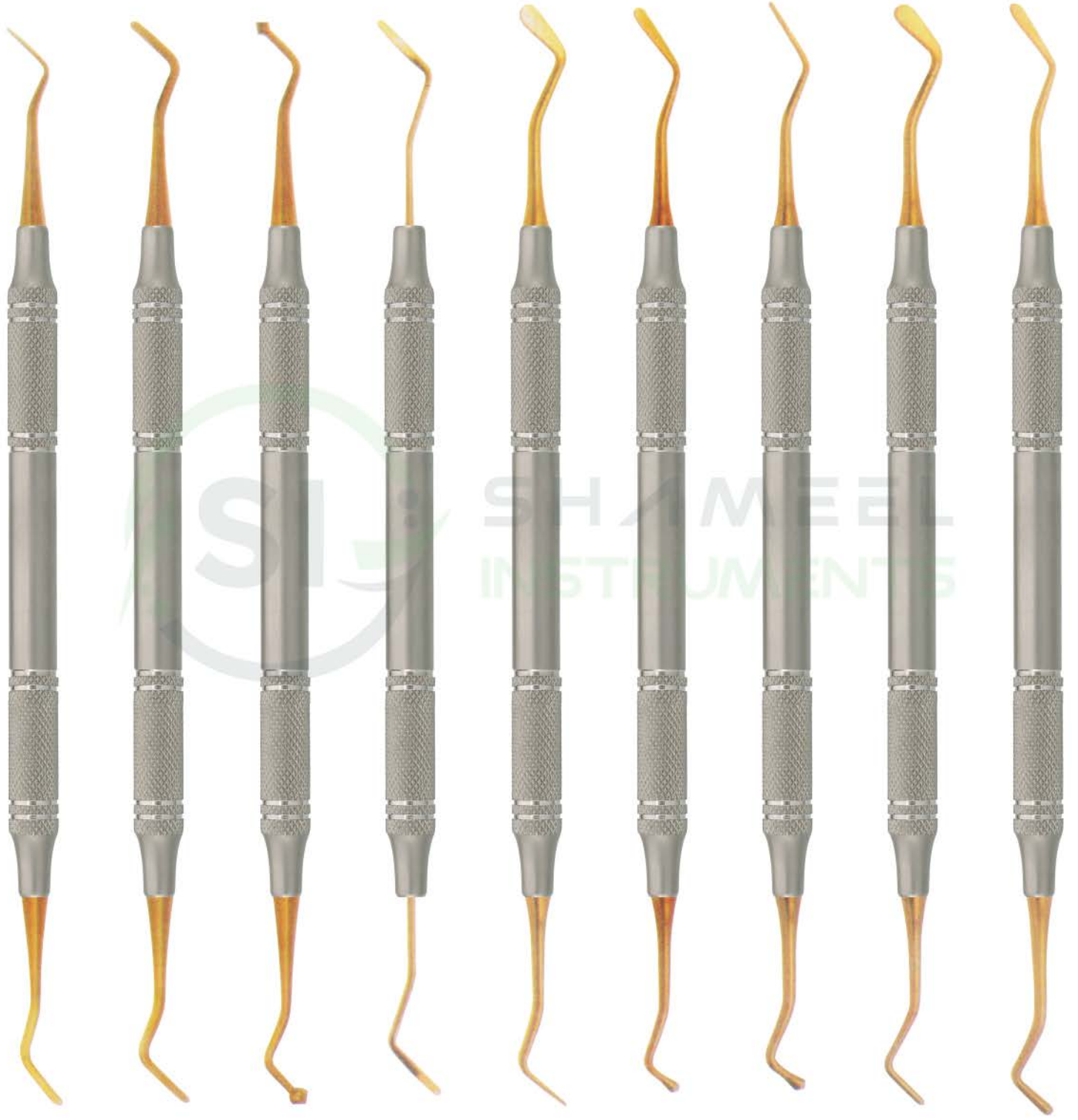

DE-1118

DE-1119

DE-1120

DE-1121

DE-1122

DE-1123

DE-1124

DE-1125

DE-1126

# COMPOSITE FILLING INSTRUMENTS



- Инструменты для реставрации
- Instruments pour plombage
- Füllungsinstrumente (mit Kontrawinkel)

- Инструменти для реставрації
- Instrumentos para obturaciones
- ملء الصكوك

## Composite Gold Tip Instruments





## MISCELLANEOUS PRODUCTS

- Прочие товары
- Divers produits et services
- Sonstige Produkte
- Інші товари
- Varios Productos
- المنتجات المتنوعة



DE-1138  
X Ray Film Hangers



DE-1139  
X Ray Film Hangers



DE-1140  
X Ray Film Hangers



DE-1141  
X Ray Film Hangers



DE-1142  
X Ray Film Hangers



DE-1143  
X Ray Film Hangers



DE-1144  
X Ray Film Hangers



DE-1145



DE-1146



DE-1147



Dissecting Set  
DE-1148 Set of 9 Pcs.  
DE-1149 Set of 11 Pcs.



DE-1150  
Napkin Holder with  
Plastic Chain



DE-1151  
Napkin holder with metal chain



Mouth Props  
DE-1152  
Small

Mouth Props  
DE-1153  
Medium

Mouth Props  
DE-1154  
Large

### Key Rings



DE-1155



DE-1156



DE-1157



DE-1158



DE-1159



DE-1160



# CEMENT SPATULAS



- Шпатели для цемента
- Spatules à ciment
- Zementspatel
- Шпателі для цементу
- Espátulas para cemento
- ملاعق الإسمنت





## WAX KNIVES

- Ножи для воска
- Couteaux a cire
- Wachsmesser
- Ножи для воску
- Cuchillos para cera
- السكاكين الشمع

ALGINATE, PLASTER SPATULAS, WAX KNIVES PLASTER FOR KNIVES & PLASTER SHEAR



**DE-1183**  
Wooden Handle  
Fig. 5  
21.5 cm



**DE-1184**  
Wooden Handle  
Fig. 7  
19.5 cm curved



**DE-1185**  
Wooden Handle  
Fig. 8  
20 cm curved



**DE-1186**  
Wooden Handle  
Fig. 9  
22.5 cm curved



**DE-1187**  
Hook Knives



**DE-1188**  
Fig. 1  
Lessmann  
12.5 cm



**DE-1189**  
Fig. 2  
Lessmann  
17 cm



**DE-1190**  
Fig. 1  
with small spoon  
12.5 cm



**DE-1191**  
Fig. 2  
with large spoon  
17 cm



**DE-1192**  
Bacolite Handle  
Wax Knives,  
Small



**DE-1193**  
Bacolite Handle  
Wax Knives,  
Large



**DE-1194**  
Wooden Handle  
Wax Knives,  
Small



**DE-1195**  
Wooden Handle  
Wax Knives,  
Large



**DE-1196**  
Plaster Knife



**DE-1197**  
Fig. 1  
17 cm



**DE-1198**  
Fig. 3  
16 cm



**DE-1199**  
Fig. 4  
16 cm



**DE-1200**  
Special Inox  
19.5 cm

# ARTICULATORS



- Артикуляторы
- Artocilar
- Artikulations

- Артикулятори
- Articuler
- آرتیکو لاتورس



**DE-1201**

**Technical Datas:**

Intercondylar distance 120 mm.  
 condylar inclination fixed at 30°  
 Bennet angle fixed at 7°  
 Incisal table inclination 10°  
 Distance between mounting plates 85 mm.  
 Weight 400 gr.  
 Opening (item 5000) 125°  
 Opening (item 5010) 180°



**DE-1202**

**Technical Datas:**

Intercondylar distance 110 mm.  
 condylar inclination fixed at 30°  
 Bennet angle fixed at 7°  
 Incisal table inclination flat  
 Distance between mounting plates 85 mm.  
 Weight 450 gr.  
 Opening 180°



**DE-1203**

Stainless Steel Finishing

**DE-1204**

Royal Blue



**DE-1205**



**DE-1206**



**DE-1207**



**DE-1208**



**DE-1209**



**DE-1210**



**DE-1211**



**DE-1212**



**DE-1213**



**DE-1214**  
 Nakawalni  
 Dental Laboratory  
 Instrument





# DENTAL PHOTOGRAPHIC MIRRORS

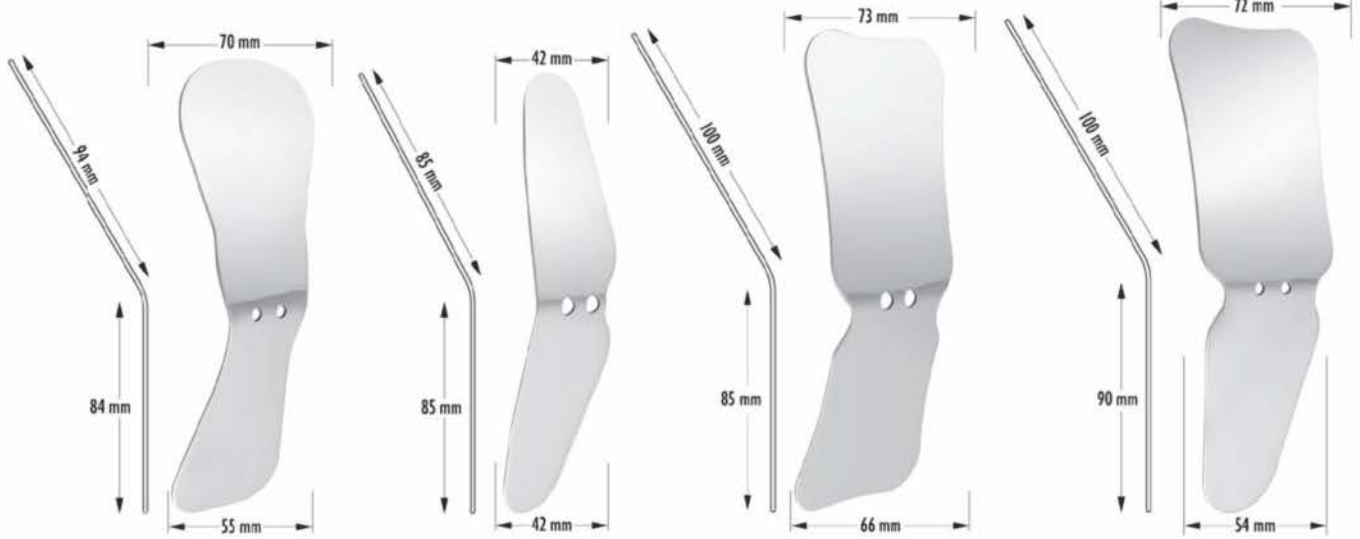

**DE-1215** Adult Palatal /  
**DE-1216** Child Palatal

**DE-1217**  
Buccal

**DE-1218** Adult Palatal /  
**DE-1219** Child Palatal

**DE-1220** Adult Palatal /  
**DE-1221** Adult Buccal



**DE-1222** Lingual upper /  
**DE-1223** Lingual Lower

**DE-1224** Adult Buccal /  
**DE-1225** Child Buccal

**DE-1226** Child Palatal /  
**DE-1227** Child Buccal

**DE-1228**  
Palatal-Adult

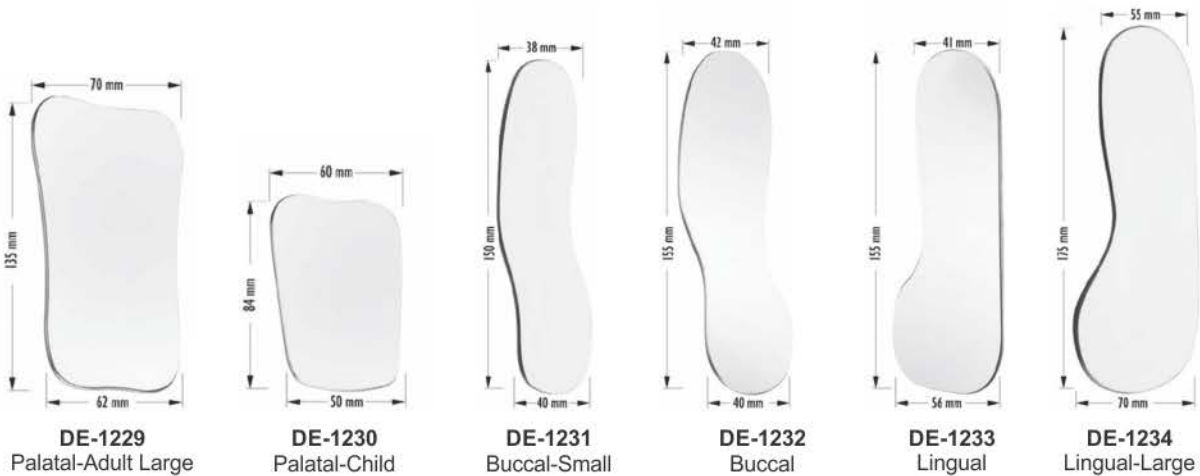

**DE-1229**  
Palatal-Adult Large

**DE-1230**  
Palatal-Child

**DE-1231**  
Buccal-Small

**DE-1232**  
Buccal

**DE-1233**  
Lingual

**DE-1234**  
Lingual-Large

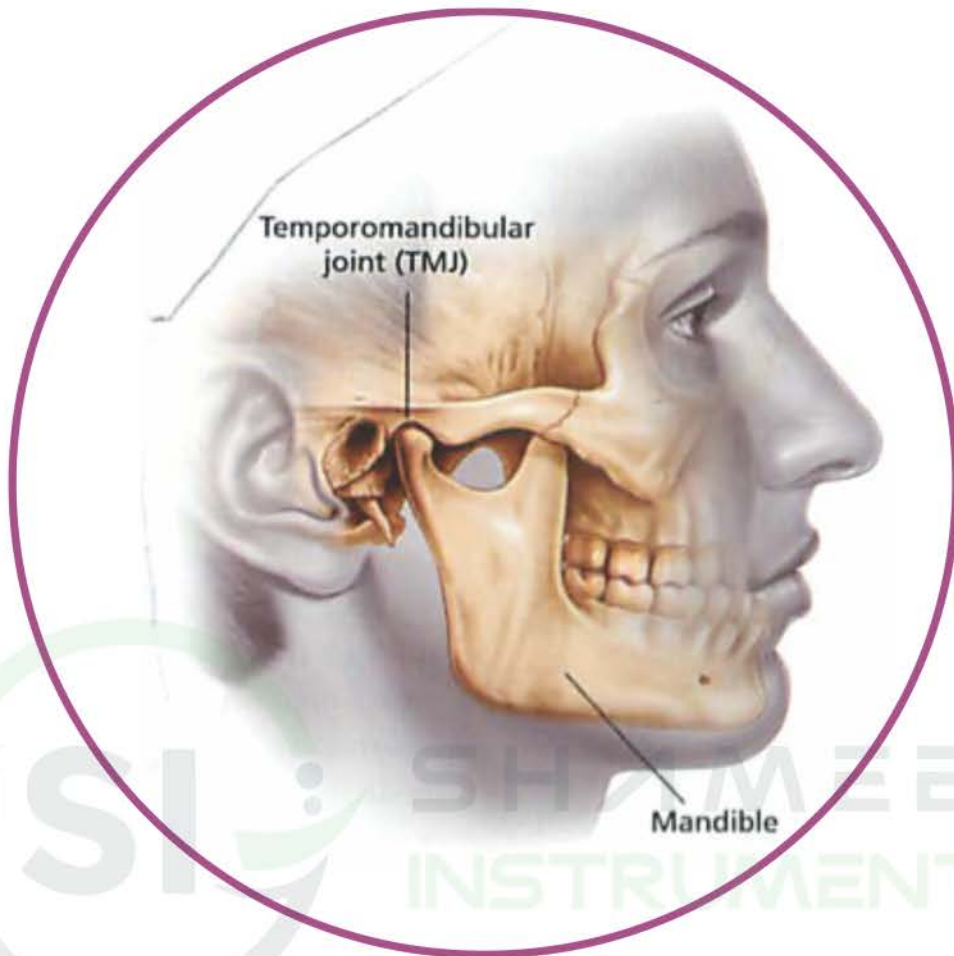



## RETRACTORS - MOUTH GAGS

- Роторасширители
- Ecarteurs - Ouvre-bouches
- Vestibulumabhalter / Mundspanner
- Роторозширювачі
- Separadores - Abre-bocas
- الكاشطات - الكمامات الفم



**DE-1251**  
HMG  
Heister  
130mm



**DE-1252**  
Mouth Gag Molt  
11 cm for (Children)



**DE-1253**  
Mouth Gag Molt  
14 cm for (Adults)



**Sternberg Retractors**  
DE-1254 140 mm  
DE-1255 180 mm



**Columbia Retractor**  
DE-1256 140 mm

SHAMEEL  
INSTRUMENTS



**DE-1257**  
Wangen Holder  
vestibule  
15 cm, with or without  
lip protection,



**DE-1258**  
Wangen Holder  
vestibule 15 cm, with  
or without lip protection



**DE-1259**  
Wangen Holder  
with dual  
function, 17 cm



**Weider Retractor**



**DE-1260**  
140 mm



**DE-1261**  
150 mm



# RETRACTORS - MOUTH GAGS



- Роторасширители
- Роторозширювачі
- Ecarteurs - Ouvre-bouches
- Separadores - Abre-bocas
- Vestibulumabhalter / Mundspanner
- الكاشطات-الكمامات الفم



Weitlaner  
Fig. 1  
DE-1262 10.5cm  
DE-1263 13.5cm



Weitlaner  
Fig. 2  
DE-1264 10.5cm  
DE-1265 13.5cm



DE-1266  
Lip & Cheek Retractor  
Stainless Steel  
Double Ended



DE-1267  
Simplex Retractor  
Stainless Steel  
Single Ended



Weitlander  
DE-1268 11cm  
DE-1269 13cm  
DE-1270 15cm



DE-1274  
Denhard  
12 cm



DE-1275  
Roser-König  
16 cm



DE-1276  
Roser-König  
19 cm



Jennings  
DE-1271 11cm  
DE-1272 13cm  
DE-1273 15cm



# RETRACTORS

- Ранорасширители
- Ecarteurs
- Wundhaken
- Ранорозширювачі
- Separadores
- الكامشات

**Wound, Bendable**  
Retractor, individually or as saving kit!



**DE-1277**  
Cheek Retainer  
One-sided  
Long



**DE-1278**  
Cheek Retainer  
One-sided  
Long



**DE-1279**  
Cheek Retainer  
One-sided  
Long



**Ergo Grip  
Retractor**  
**DE-1280** 24 cm  
ergonomic handle,



**Ivory Retractors**  
Width adjustable  
& fixable,  
**DE-1281** 20 cm



**Bruenings Retractors**  
tongue depressors  
**DE-1282** 19 cm



**Minnesota  
Retractors**  
**DE-1283** 16 cm



**Ribbon Retractors**  
**DE-1284** 20 cm  
easy to bend  
by hand,



**Bishop Retractors**  
retractor and tongue  
pushers Bishop with  
comfortable margin  
**DE-1285** 16 cm



**Combination  
Retractors**  
**DE-1286** 25 cm

# RETRACTORS



- Ранорасширители
- Ранорозширювачі
- Ecarteurs
- Separadores
- Wundhaken
- الكاشحات



**DE-1287**  
Unique Retractors  
Length 175 mm  
angled 45°



**DE-1288**  
Unique Retractors  
Length 175 mm  
angled 90°



**DE-1289**  
Retractors  
16cm



**DE-1290**  
Retractors  
19cm



**DE-1291**  
Mini-Langenbeck  
Retractors  
16 cm, hooks 22 mm



**DE-1292**  
US army Retractors  
21 cm, 2



**DE-1293**  
ALM Retractor  
about 8 cm



**DE-1294**  
Senn Mueller Retractor  
17 cm, hooks 22 mm





## RETRACTORS

- Ранорасширители
- Ecarteurs
- Wundhaken
- Ранорозширювачі
- Separadores
- الكاشحات



**DE-1295**  
Langenbeck Retractors  
surgical-flat  
21 cm, hook  
30x16 mm



**DE-1296**  
Langenbeck Retractors  
surgical-flat  
21 cm, hook  
42x11 mm



**DE-1297**  
Langenbeck Retractors  
surgical-flat  
21 cm, hook  
63x12 mm



Langenbeck Retractors  
surgical-flat  
21 cm, hook  
**DE-1298** 30x16 mm  
**DE-1299** 42x11 mm  
**DE-1300** 63x12 mm



Langenbeck Retractors  
21 cm, hook  
**DE-1301** 30x11 mm  
**DE-1302** 30x16 mm



**DE-1303**  
Middelborpf  
Retractors  
21 cm



**DE-1304**  
Farabeuf  
(120 X 12mm  
Set of 2 pices)



**DE-1305**  
Retractor Seldin



**DE-1306**  
Feldman Retractor  
14cm

# GUM SCISSORS



- Ножницы десневые
- Ciseaux a gencives
- Zahnfleischscheren

- Ножиці для ясен
- Tijeras para encias
- مقص صمغ



**DE-1307**  
Iris  
115mm  
Straight

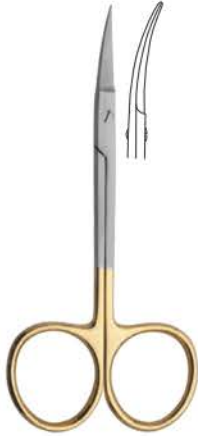

**DE-1308**  
Iris  
115mm  
Curved



**DE-1309**  
Goldman-Fox  
130mm  
Saw edge, straight



**DE-1310**  
Goldman-Fox  
130mm  
Saw edge, Curved



**DE-1311**  
La Grange  
115mm  
Saw edge, double Curved



Mayo  
**DE-1312** 140mm  
**DE-1313** 170mm  
**DE-1314** 230mm  
Straight



Mayo  
**DE-1315** 140mm  
**DE-1316** 170mm  
**DE-1317** 230mm  
Curved



Metzenbaum  
**DE-1318** 145mm  
**DE-1319** 180mm  
**DE-1320** 200mm  
Straight



Metzenbaum  
**DE-1321** 145mm  
**DE-1322** 180mm  
**DE-1323** 200mm  
Curved



**DE-1324**  
Kelly  
160mm  
Straight



**DE-1325**  
Kelly  
160mm  
Curved



**DE-1326**  
Iris  
115mm  
Straight



**DE-1327**  
Iris  
115mm  
Curved



**DE-1328**  
La Grange  
115mm  
Double Curved



**DE-1329**  
Goldman-Fox  
130mm, Straight



**DE-1330**  
Goldman-Fox  
130mm, Curved



**DE-1331**  
Kelly  
160mm, Curved



**DE-1332**  
Iris  
115mm, Straight



**DE-1333**  
Iris  
115mm, Curved



**DE-1334**  
Micro Iris  
90mm, Curved



# GUM SCISSORS

- Ножницы десневые
- Ciseaux a gengivas
- Zahnfleischscheren
- Ножиці для ясен
- Tijeras para encias
- مقص صمغ



**DE-1335**  
Iris  
115mm  
Angled



**DE-1336**  
Iris  
115mm  
Curved



**DE-1337**  
Goldman-Fox  
130mm  
Saw edge,  
straight



**DE-1338**  
Goldman-Fox  
130mm  
Saw edge,  
curved



**DE-1339**  
Goldman-Fox  
130mm  
Saw edge,  
double curved



**DE-1340**  
La Grange  
115mm  
Saw edge,  
double curved



**DE-1341**  
Neumann  
120mm  
Saw edge,  
double curved



**DE-1342**  
Kilner (Ragnell)  
120mm  
Straight



**DE-1343**  
Kilner (Ragnell)  
120mm  
Curved



**DE-1344**  
Joseph  
140mm  
Straight



**DE-1345**  
Joseph  
140mm  
Curved



**DE-1346**  
Kelly  
160mm  
Straight



**DE-1347**  
Kelly  
160mm  
Curved



**DE-1348**  
Locklin  
160mm  
Saw edge,  
angular



**DE-1349**  
Locklin  
120mm

**DE-1350**  
160mm  
Saw edge, angular



**DE-1351**  
Dean  
170mm  
Saw edge,  
angular

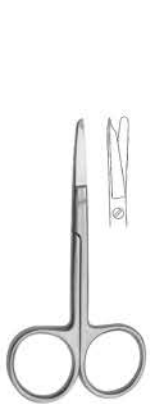

**DE-1352**  
Spencer  
90mm



**DE-1353**  
Spencer  
130mm



**DE-1354**  
Spencer  
115mm



**DE-1355**  
Noyes  
110mm, Straight



**DE-1356**  
Noyes  
110mm  
Curved



**DE-1357**  
Noyes  
110mm  
Angular



**DE-1358**  
Castroviejo  
150mm  
Curved



## GUM SCISSORS

## NEEDLE HOLDERS

- Ножницы десневые
- Ciseaux a gengivas
- Zahnfleischscheren

- Ножиці для ясен
- Tijeras para encias
- مقص صمغ

- Иглодержатели
- Porte-aiguilles
- Nadelhalter

- Голкотримачі
- Porta-agujas
- اصحاب ابرة



**DE-1359**  
130mm  
Straight



**DE-1360** Mayo Mayo  
**DE-1361** 130mm 130mm  
**DE-1362** 160mm 160mm  
180mm 180mm  
Straight Curved



**DE-1363** Mayo Mayo  
**DE-1364** 140mm 140mm  
200mm 200mm  
Straight Curved



**DE-1365** Metzzenbaum  
145mm 145mm  
**DE-1366** 200mm 200mm  
Straight Curved



**DE-1367**  
Beebee  
110mm  
Saw edge,  
straight



**DE-1368**  
Beebee  
110mm  
Saw edge,  
curved



**DE-1369**  
Beebe  
110mm  
Saw edge, straight



**DE-1370**  
Beebe  
110mm  
Saw edge, curved

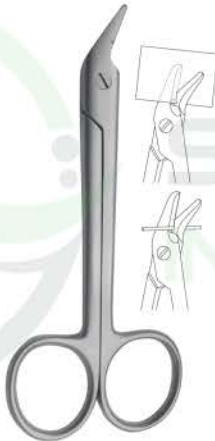

**DE-1371**  
Universal  
120mm  
Saw edge



**DE-1372**  
Universal  
120mm



Ryder  
**DE-1373** 130mm  
**DE-1374** 150mm  
**DE-1375** 180mm



**DE-1376**  
Halsey  
130mm



**DE-1377**  
Baumgartner  
130mm



**DE-1378**  
Derf  
120mm



**DE-1379**  
Delicate  
150mm



Mayo-Hegar  
**DE-1380** 130mm  
**DE-1381** 160mm  
**DE-1382** 180mm  
**DE-1383** 200mm



**DE-1384**  
Crile-Wood  
150mm  
straight



**DE-1385**  
Crile-Wood  
150mm  
curved

# NEEDLE HOLDERS

- Иглодержатели
- Porte-aiguilles
- Nadelhalter

- Голкотримачи
- Porta-agujas
- أصحاب إبرة

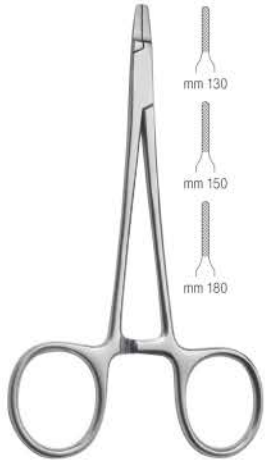

Ryder  
**DE-1386** 130mm  
**DE-1387** 150mm  
**DE-1388** 180mm



**DE-1389**  
 Halsey  
 130mm



**DE-1390**  
 Baumgartner  
 130mm



**DE-1391**  
 Derf  
 120mm



**DE-1392**  
 Delicate  
 150mm



**DE-1393**  
 Adson  
 170mm



Mayo-Hegar  
**DE-1394** 130mm  
**DE-1395** 160mm  
**DE-1396** 180mm  
**DE-1397** 200mm



**DE-1398**  
 Crile-Wood  
 150mm



Castroviejo  
**DE-1399** str 140mm cvd  
**DE-1400** str 180mm cvd



Olsen-Hegar Needle  
 Holder With Scissors  
**DE-1401** 140mm



Gillies Needle  
 Holder With Scissors  
**DE-1402** 160mm



Mathieu  
**DE-1403** 140mm  
**DE-1404** 170mm



Castroviejo  
**DE-1405** str 140mm cvd  
**DE-1406** str 180mm cvd



Olsen-Hegar Needle  
 Holder With Scissors  
**DE-1407** 140mm



Gillies Needle  
 Holder With Scissors  
**DE-1408** 160mm

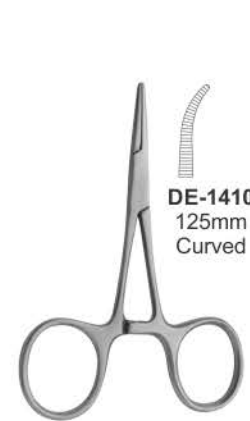

Hartmann (Baby  
 Mosquito)  
**DE-1409** 90mm straight



Halstead Mosquito  
**DE-1411** 125mm  
 Straight

**DE-1410**  
 125mm  
 Curved

**DE-1412**  
 Curved

## GUM SCISSORS



- Ножницы десневые
- Ciseaux a gencives
- Zahnfleischscheren
- Ножцици для ясен
- Tijeras para encias
- مقص صمغ



**DE-1413**  
Goldman Fox Scissors  
12.5cm Curved



**DE-1414**  
Iris Scissors  
11.5cm Curved  
Serrated For Slip-Free Cutting



**DE-1415**  
LaGrange Scissors  
11.5cm Double Curved  
Serrated For Slip-Free Cutting

Double  
Curved



**DE-1416**  
Castroviejo Micro Scissors  
12cm Curved



**DE-1417**  
Super Cut Goldman Fox  
13.2cm Curved  
Serrated For Slip-Free Cutting



**DE-1418**  
Super Cut Iris  
11cm Straight  
Serrated For Slip-Free Cutting



**DE-1419**  
Super Cut Iris  
11cm Curved  
Serrated For Slip-Free Cutting

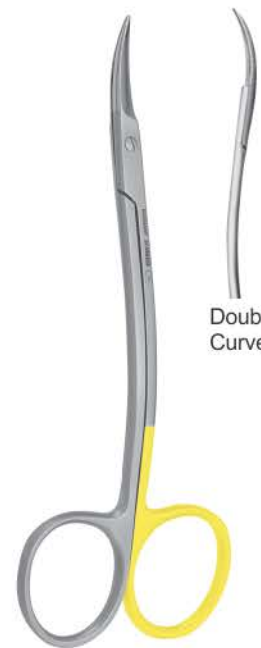

**DE-1420**  
Super Cut LaGrange  
11.5cm  
Double Curved  
Serrated For Slip-Free Cutting

Double  
Curved





# NEEDLE HOLDERS

- Иглодержатели
- Porte-aiguilles
- Nadelhalter

- Голкотримачи
- Porta-agujas
- اصحاب ابرة



**DE-1421**  
Lichtenberg-  
Ryder T.C  
14 cm



**DE-1422**  
Lichtenberg-  
Ryder T.C  
14 cm



**DE-1423**  
Lichtenberg-  
Ryder T.C  
17 cm



**DE-1424**  
Lichtenberg-  
Ryder T.C  
17 cm



**DE-1425**  
Barraquer  
18 cm



**DE-1426**  
Barraquer  
18 cm



**DE-1427**  
Barraquer T.C  
18 cm



**DE-1428**  
Barraquer T.C  
18 cm

**DE-1429**  
Tönnis  
18 cm



**DE-1430**  
Castroviejo  
13 cm  
Straight



**DE-1431**  
Kalt Needle Holders T.C  
14 cm Straight



**DE-1432**  
Peet Splinter Forceps  
11.5 cm

**DE-1433**  
La Grange  
Curved



**DE-1434**  
All-Purpose Pliers

# HAEMOSTATIC FORCEPS & TOWEL CLAMPS



- Зажимы артериальные, зажимы для салфеток
- Pincas hemostatiques, Pincas a compresas
- Arterienklemmen, Tuschklemmen
- Затискачі артеріальні, затискачі для серветок
- Pinzas hemostaticas, Pincas para compresas
- الملقط هایموستاتیک المشابک منشفه

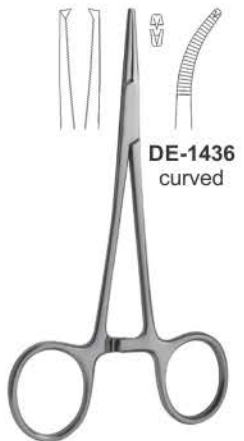

**DE-1436**  
curved

Halstead Mosquito 1x2  
**DE-1435** 125mm  
straight

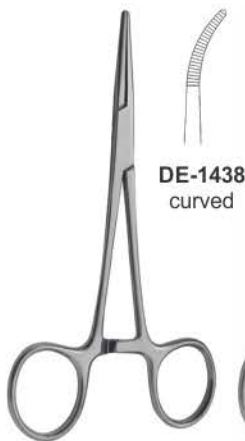

**DE-1438**  
curved

Kelly  
**DE-1437** 140mm  
straight



**DE-1443** 140mm  
**DE-1444** 160mm  
**DE-1445** 180mm  
**DE-1446** 200mm  
curved

Rochester-Pean  
**DE-1439** 140mm  
**DE-1440** 160mm  
**DE-1441** 180mm  
**DE-1442** 200mm  
straight

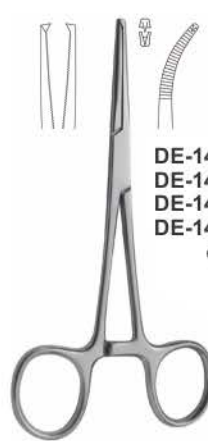

**DE-1451** 140mm  
**DE-1452** 160mm  
**DE-1453** 180mm  
**DE-1454** 200mm  
curved

Rochester-Kocher 1x2  
**DE-1447** 140mm  
**DE-1448** 160mm  
**DE-1449** 180mm  
**DE-1450** 200mm  
straight

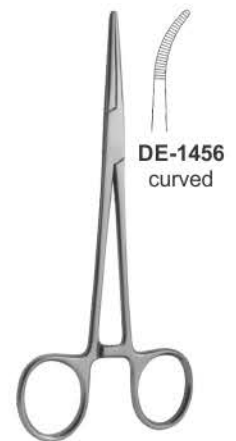

**DE-1455**  
curved

**DE-1455**  
Kelly-Rankin  
160mm  
straight

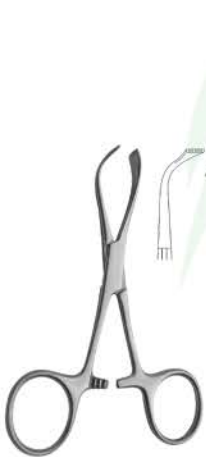

Lorna  
**DE-1457** 100mm  
**DE-1458** 130mm



**DE-1459**  
Allis-Baby 3:4  
150mm



**DE-1460**  
Allis 4:5  
200mm



**DE-1461**  
Allis 6:7  
200mm

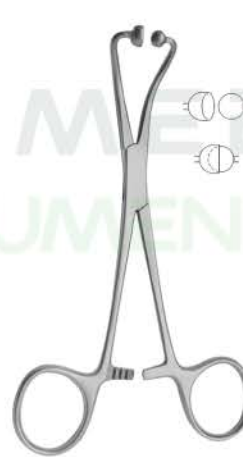

Ball Socket  
**DE-1462** 140mm  
Not-perforating and  
not-damaging

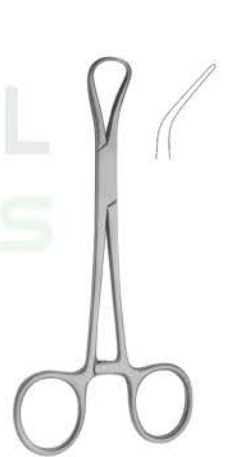

**DE-1463**  
Backhaus  
130mm



**DE-1464**  
Backhaus  
85mm



**DE-1465**  
Jones  
90mm

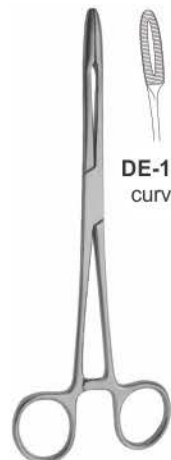

**DE-1139**  
curved

Gross Maier  
Dressing Forceps  
**DE-1466** 200mm straight



Foerster  
Dressing Forceps  
**DE-1467** 200mm



Spare rubber

Young  
Tongue Forceps  
**DE-1468** 170mm



Collins  
Tongue Forceps  
**DE-1469** 170mm



# RUBBER DAM CLAMPS FORCEPS

- Инструменты для системы коффердам
- Pinces porte-crampons a digue
- Kofferdam Klammerzangen
- Инструменти для системи коффердам
- Pinzas de engrapar para dique de caucho
- السد العظام الملقط المشابك



### DE-1470

On request the Content of the rubber dam kit can be changed with other instruments.

#### Content:

- 01 Anisworth
- 02 Brewer
- 03 Clamps Stand
- 04 Denture Plate
- 05 Rubber Dam Frame
- 06 Rubber Dam Box Lower Case
- 07 Rubber Dam Box Upper Case
- 08 Rubber Dam Clamp Fig. 212
- 09 Rubber Dam Clamp Fig. 211
- 10 Rubber Dam Clamp Fig. 8
- 11 Rubber Dam Clamp Fig. 8A
- 12 Rubber Dam Clamp Fig. 14
- 13 Rubber Dam Clamp Fig. 14A
- 14 Rubber Dam Clamp Fig. 0
- 15 Rubber Dam Clamp Fig. 00
- 16 Rubber Dam Clamp Fig. 2
- 17 Rubber Dam Clamp Fig. 2A
- 18 Rubber Dam Clamp Fig. 7

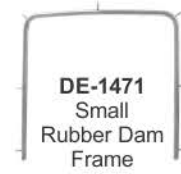

DE-1471  
Small  
Rubber Dam  
Frame



DE-1472  
Medium  
Rubber Dam  
Frame

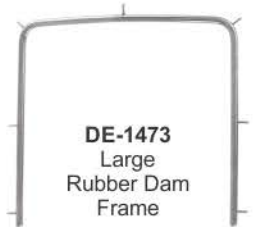

DE-1473  
Large  
Rubber Dam  
Frame



DE-1474  
Brewer



DE-1475  
Stockes



DE-1476  
Palmer



DE-1477  
Ivory light weight



DE-1478  
Anisworth



DE-1479  
Anisworth



Punch Plier



DE-1480  
Anisworth



DE-1481  
Ivory



DE-1482  
Separating  
Elastic Plier



# RUBBER DAM CLAMPS KITS



- Резиновая дамба зажимы комплекты
- Trousses de caoutchouc
- Gummidammklammern
- Гумова дамба затискачі комплекти
- Conjuntos de abrazaderas de retención de caucho
- المطاط السد المشابك مجموعات



**DE-1483**

Stainless Steel Gold Plated Rubber Dam Clamp Tray with 11 Different Clamps  
Fig. 212, 211, 8, 8A, 14, 14A, 0, 00, 2, 2A, 7

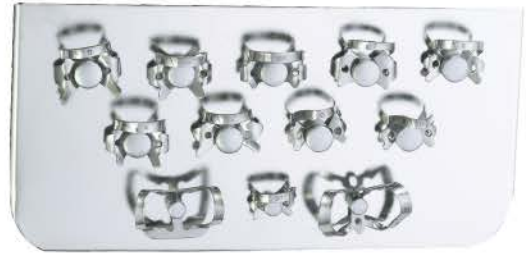

**DE-1484**

Stainless Steel Rubber Dam Clamp Tray with 12 Different Clamps  
Fig. 209, 212, 211, 8, 8A, 14, 14A, 0, 00, 2, 2A, 7



**DE-1485**

Stainless Steel Rubber Dam Clamp Tray with 8 Different Clamps  
Fig. 1, 26, 29, 51, 60, 202, 205, 210



**DE-1486**

Stainless Steel Rubber Dam Clamp Tray  
(without clamps)



**DE-1487**

On request the Content of the rubber dam kit can be changed with other instruments.

**Content:**

- 01 Ivory
- 02 Ivory light weight
- 03 Clamps Stand
- 04 Rubber Dam Frame M
- 05 Rubber Dam Frame L
- 06 Rubber Dam Box Lower Case
- 07 Rubber Dam Box Upper Case

- 08 Rubber Dam Clamp Fig. 209
- 09 Rubber Dam Clamp Fig. 212
- 10 Rubber Dam Clamp Fig. 211
- 11 Rubber Dam Clamp Fig. 8
- 12 Rubber Dam Clamp Fig. 8A
- 13 Rubber Dam Clamp Fig. 14
- 14 Rubber Dam Clamp Fig. 14A
- 15 Rubber Dam Clamp Fig. 0
- 16 Rubber Dam Clamp Fig. 00
- 17 Rubber Dam Clamp Fig. 2
- 18 Rubber Dam Clamp Fig. 2A
- 19 Rubber Dam Clamp Fig. 7

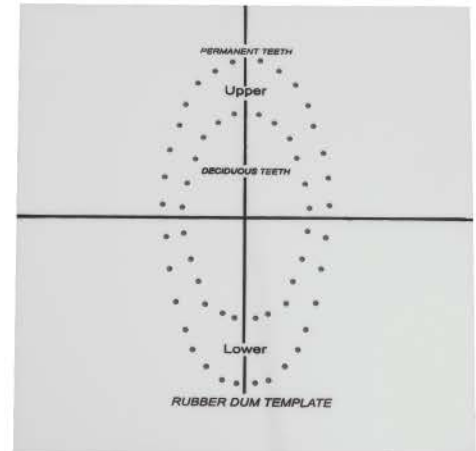

**DE-1488**  
Rubber Dum Template



# RUBBER DAM CLAMPS

- Кляммера для коффердама
- Crampons pour digue
- Kofferdam Klammern
- Кляммера для коффердама
- Grapas para dique de caucho
- المشابك السد المطاط



DE-1489  
Fig. 15



DE-1490  
Fig. 18



DE-1491  
Fig. 24



DE-1492  
Fig. 25



DE-1493  
Fig. 26



DE-1494  
Fig. 28



DE-1495  
Fig. 30



DE-1496  
Fig. 31



DE-1497  
Fig. 51



DE-1498  
Fig. 138



DE-1499  
Fig. 139



DE-1500  
Fig. 200



DE-1501  
Fig. 201



DE-1502  
Fig. 202



DE-1503  
Fig. 203



DE-1504  
Fig. 204



DE-1505  
Fig. 205



DE-1506  
Fig. 3



DE-1507  
Fig. W3



DE-1508  
Fig. 4



DE-1509  
Fig. 56A



DE-1510  
Fig. 7



DE-1511  
Fig. 7A



DE-1512  
Fig. 8



DE-1513  
Fig. 8A



DE-1514  
Fig. W8A



DE-1515  
Fig. 10



DE-1516  
Fig. 11



DE-1517  
Fig. 12A



DE-1518  
Fig. 13A



DE-1519  
Fig. 14



DE-1520  
Fig. 14A



DE-1521  
Fig. 14AN



DE-1522  
Fig. 22



DE-1523  
Fig. 27



DE-1524  
Fig. 207



DE-1525  
Fig. 29



DE-1526  
Fig. 206



DE-1527  
Fig. 208



DE-1528  
Fig. 209



DE-1529  
Fig. 1



DE-1530  
Fig. 1A



DE-1531  
Fig. 2



DE-1532  
Fig. 2A



DE-1533  
Fig. W2A



DE-1534  
Fig. 0



DE-1535  
Fig. 00



DE-1536  
Fig. 210



DE-1537  
Fig. 211



DE-1538  
Fig. 212



DE-1539  
Fig. 6



DE-1540  
Fig. 9



DE-1541  
Fig. N06



DE-1542  
Fig. U67



DE-1543  
Fig. 214



DE-1544  
Fig. P1



DE-1545  
Fig. P2



DE-1546  
Fig. G-1



DE-1547  
Fig. G-2



# CROWN REMOVER

- Инструменты для удаления коронок
- Arrache-couronnes
- Teleskopkronenzangen
- Инструменты для видалення коронок
- Arranca-corona
- مزيلات التاج



**DE-1548**  
Crown Spreaders



**DE-1550**  
Universal  
Fig. 0



Manual Crown Removers  
Handle with 3 tips **DE-1551**  
Only 3 tips **DE-1552 to DE-1554**



**DE-1552** **DE-1553**



**DE-1554**



Manual Crown Removers  
Handle with 3 tips **DE-1555**  
Only 3 tips **DE-1556 to DE-1558**



**DE-1556** **DE-1557**



**DE-1558**



**DE-1559**  
Manual Crown  
Remover



**DE-1560**  
Manual Crown Remover



**DE-1561**  
Complete with 3 tips  
and tightening keys

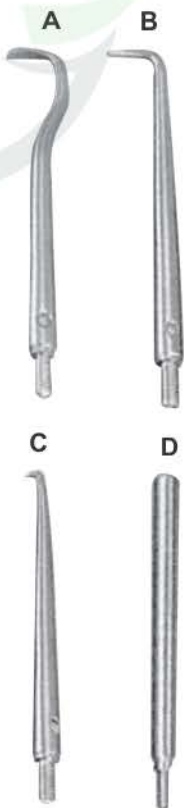

semi-automatic crown  
& bridge remover



**DE-1562**



**A** **B**

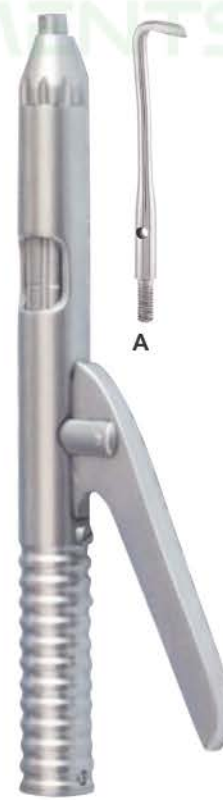

**DE-1563**  
Manual Crown Remover



**A** **B** **C**



**D** **E**





# MATRIX RETAINERS

- Матрицедержатели
- Porte Matrices
- Matrizenspanner
- Матрицеутримувачи
- Porta Matrices
- مصفوفة الخدم



**DE-1564**  
Fig. 5  
Ivory 8  
5 cm



**DE-1565**  
Fig. 6  
Ivory 8  
6 cm



**DE-1566**  
Fig. 7  
Ivory 8  
7 cm



**DE-1567**  
Fig. 1  
Tofflemire-Universal



**DE-1568**



**DE-1569**



**DE-1570**

## Siqveland Retainers



**DE-1571**  
Fig. 2  
Tofflemire-Junior



**DE-1572**  
Fig. 3  
Tofflemire-Senior



**DE-1573**  
Narrow



**DE-1574**  
Wide

## Amalgam Well



**DE-1575**  
Stainless Steel  
Amalgam Well



**DE-1576**  
Ivory 12



**DE-1577**  
Ivory 1



**DE-1578**  
Ivory



**DE-1579**  
Elliot

# AMALGAM INSTRUMENTS



- Инструменты для амальгамы
- Instruments pour amalgame
- AmalgamisInstrumente
- Инструменти для амальгами
- Instrumentos para amalgama
- الصكوك الملعغم



**DE-1580**  
Fig. 10  
165mm  
English pattern



**DE-1581**  
Fig. 1  
185mm  
German pattern



**DE-1582**  
Fig. 1  
150mm  
Swiss pattern



**DE-1583**  
Fig. 1  
150mm



**DE-1584**  
Fig. 2  
150mm, 45°



**DE-1585**  
Fig. 3  
140mm, 90°



**DE-1586**  
Chip Blower



**DE-1587**



**DE-1588**



**DE-1589**



**DE-1590**  
Water Syringe



# AMALGAM INSTRUMENTS

- Инструменты для амальгамы
- Instruments pour amalgame
- Amalgamis\instrumente
- Инструменти для амальгами
- Instrumentos para amalgama
- الصوك الملقم

## AMALGAM CARRIERS

TIP SIZES FOR DISTAL OR SINGLE-END

1.5 mm



**DE-1592**  
Mini/  
Single-End

2.0 mm



**DE-1593**  
Regular  
Single-End

2.8 mm



**DE-1594**  
Large  
Single-End

1.5 mm



**DE-1595**  
Mini  
Distal

2.0 mm



**DE-1596**  
Regular  
Distal

TIP SIZES FOR DOUBLE-END

1.5 mm



2.0 mm  
**DE-1597**  
Mini/  
Regular

2.8 mm



2.0 mm  
**DE-1598**  
Large/  
Regular

3.2 mm



2.0 mm  
**DE-1599**  
Jumbo/  
Regular



**DE-1600**  
Amalgam  
Well

**DE-1591**  
Single-End

TIP SIZES FOR DOUBLE-END

**DE-1601** - 1.5mm-2.0mm  
**DE-1602** - 2.0mm-2.8mm  
**DE-1603** - 2.0mm-3.2mm

**DE-1604** - 1.0mm-2mm  
**DE-1605** - 2.0mm-3mm  
**DE-1606** - 2.0mm-4mm

**DE-1607** - 1.5mm-2.0mm  
**DE-1608** - 2.0mm-2.8mm  
**DE-1609** - 2.0mm-3.2mm

**DE-1610** - 1.0mm-2mm  
**DE-1611** - 2.0mm-3mm  
**DE-1612** - 2.0mm-4mm

**DE-1613** - 1.5mm-2.0mm  
**DE-1614** - 2.0mm-2.8mm  
**DE-1615** - 2.0mm-3.2mm

**DE-1616** - 1.0mm-2mm  
**DE-1617** - 2.0mm-3mm  
**DE-1618** - 2.0mm-4mm

**DE-1619** - 1.5mm-2.0mm  
**DE-1620** - 2.0mm-2.8mm  
**DE-1621** - 2.0mm-3.2mm

**DE-1622** - 1.0mm-2mm  
**DE-1623** - 2.0mm-3mm  
**DE-1624** - 2.0mm-4mm

**DE-1625** - 1.5mm  
**DE-1626** - 2.0mm  
**DE-1627** - 2.0mm  
**DE-1628** - 3.0mm





DE-1629 DE-1630 DE-1631 DE-1632



DE-1633  
4mm  
(Straight)



DE-1634  
4mm  
(Curved)



DE-1635  
6mm  
(Straight)



DE-1636  
6mm  
(Curved)

Periodontal Chisels

SHAMEEL  
INSTRUMENTS



7.5mm



DE-1637



4.5mm



DE-1638



7.5mm



DE-1639



4.5mm



DE-1640



## ROOT PLANNING FILES & BONE FILES

### ROOT PLANNING FILES



**DE-1641**  
Kramer-Nevens  
Bone Chisel



**DE-1642**  
Kramer-Nevens  
Bone Chisel



**DE-1643**  
Molt 18.5cm  
Auto Clavable  
Plastic Tips.

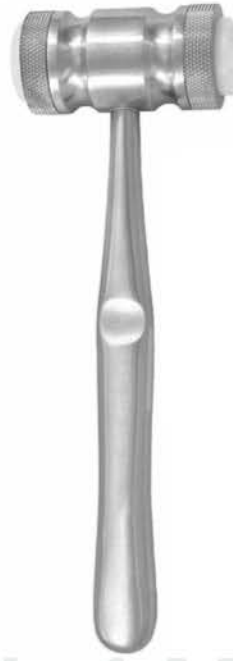

**DE-1644**  
Mead 18.5cm  
Non Auto Clavable  
Plastic Tips.



**DE-1645**  
Miller



**DE-1646**  
Miller

### BONE FILES



**DE-1647**  
Miller 21



**DE-1648**  
Miller 1X  
cross cut



**DE-1649**  
Miller 2X  
cross cut



**DE-1650**  
Miller 52



**DE-1651**  
Wahl 1

# PERIODONTAL INSTRUMENTS



- Инструменты пародонтологические
- Instruments pour la parodontologie
- Instrumente für die Parodontologie
- Інструменти пародонтологічні
- Instrumentos para periodoncia
- الصكوك اللثة

## PERIOSTEEL ELEVATORS



DE-1652 Ohl 10      DE-1653 Howard 9H      DE-1654 Freer      DE-1655 Freer 15      DE-1656 Freer 16      DE-1657 Raspator, Raspatory Length 175 mm (10.0mm)      DE-1658 Raspator, Raspatory Length 175 mm (6.4mm)      DE-1659 Raspator, Raspatory Length 175 mm (3.0mm)

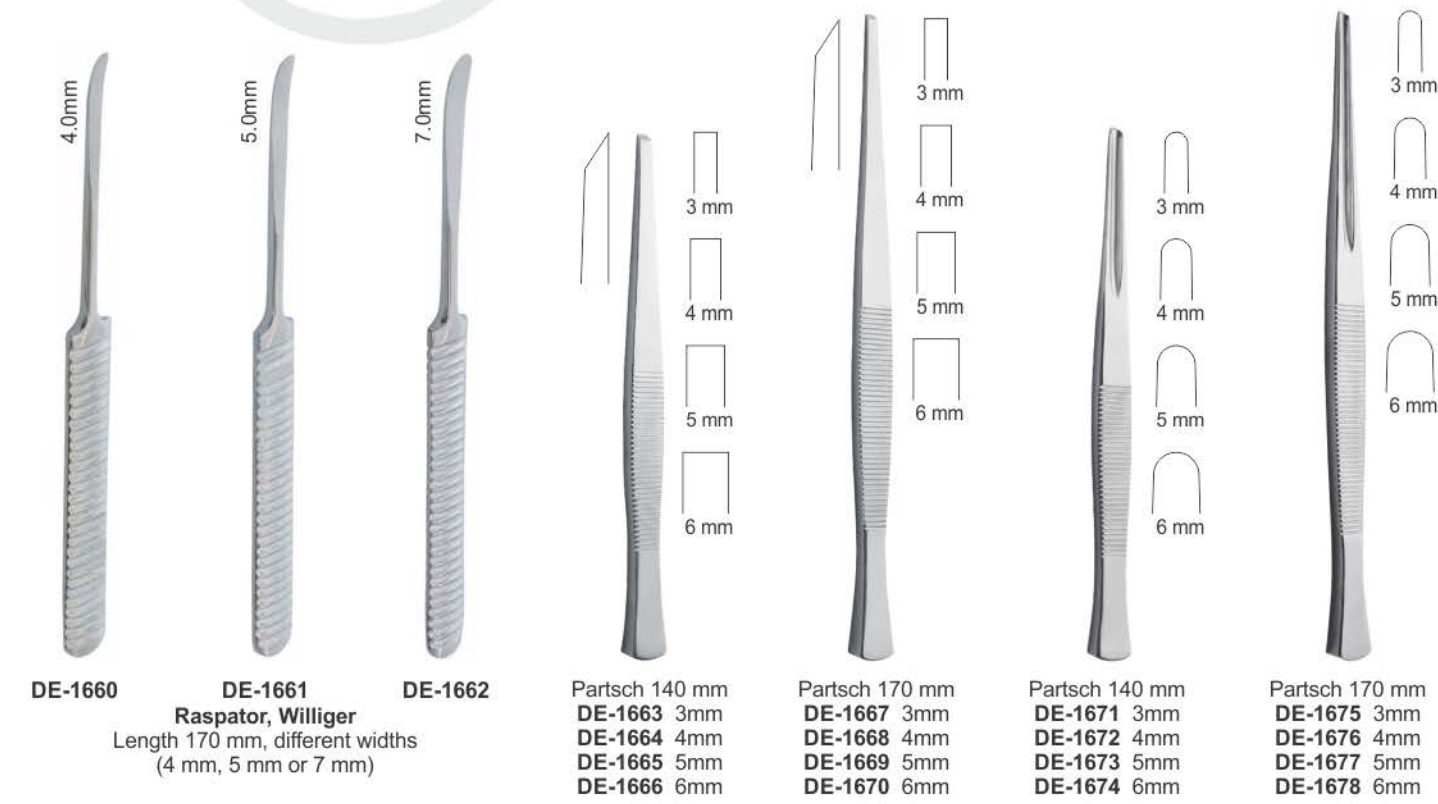

DE-1660      DE-1661      DE-1662      Partsch 140 mm      Partsch 170 mm      Partsch 140 mm      Partsch 170 mm

Raspator, Williger  
Length 170 mm, different widths  
(4 mm, 5 mm or 7 mm)

DE-1663 3mm      DE-1667 3mm      DE-1671 3mm      DE-1675 3mm

DE-1664 4mm      DE-1668 4mm      DE-1672 4mm      DE-1676 4mm

DE-1665 5mm      DE-1669 5mm      DE-1673 5mm      DE-1677 5mm

DE-1666 6mm      DE-1670 6mm      DE-1674 6mm      DE-1678 6mm





## PERIODONTAL INSTRUMENTS

- Инструменты пародонтологические
- Instruments pour la parodontologie
- Instrumente für die Parodontologie
- Инструменти пародонтологічні
- Instrumentos para periodoncia
- الصكوك اللثة

To separate tissue tooth or bone. tp hold tissue away from surgical site.



# PERIODONTAL INSTRUMENTS



- Инструменты пародонтологические
- Instruments pour la parodontologie
- Instrumente für die Parodontologie
- Инструменти пародонтологічні
- Instrumentos para periodoncia
- الصكوك اللثة



DE-1689



DE-1690  
P24G



DE-1691  
titanium Periosteal Elevator for Implan5



DE-1692  
S1



DE-1693  
Hirschfeld



DE-1694  
9S



10mm

DE-1695  
Selden

13mm



4.8 mm

Prichard

10.6 mm

DE-1696  
Friedmann



DE-1697  
Schmidlin

6.9 mm



## SCALPEL HANDLES

- Ручки для скальпелей
- Manches de bistouris
- Skalpellgriffe
- Ручки для скальпелів
- Mangos de bisturi
- مشرط مقابض



**DE-1698**  
Fig.3  
12.7cm



**DE-1699**  
Fig.3G  
12.7cm



**DE-1700**  
Fig.4  
13.7cm



**DE-1701**  
Double Handle  
No.4 + No.3  
16.3cm



**DE-1702**  
Fig. 7  
16.5cm



**DE-1703**  
Scalpel Handle Straight  
for blades #10-15  
14.5cm



**DE-1704**  
Micro Surgical Scalpel  
Handle titanium  
13.5cm



**DE-1705**  
Fig. 5  
14.5cm



**DE-1706**  
Fig. 5A  
14.5cm

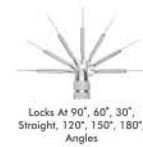

**DE-1707**  
6 Way Adjustable Angled  
Scalpel Handle





**DE-1708**  
Metal tip  
220 mm  
Hammer With Wooden Handle



**DE-1709**  
Metal tip  
220 mm

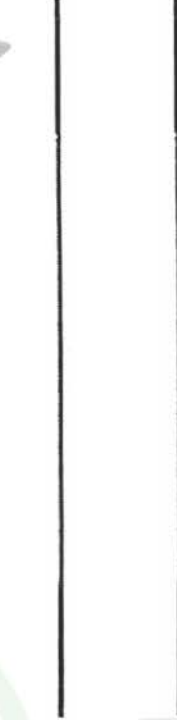

**DE-1710**  
1  
For plaster

**DE-1711**  
2  
For metal



**DE-1712**  
Fret saw  
250 mm



**DE-1713**  
Small  
Saw Blades



**DE-1714**  
Large  
Saw Blades



**DE-1715**  
Ceri Saw



Special Inox  
**DE-1716** 170mm  
**DE-1717** 200mm



**DE-1718**  
Plaster Shears  
200 mm



Crucible Tongs  
**DE-1719** 250 mm  
**DE-1720** 320 mm



**DE-1721**  
Ceri Saw  
180 mm



**DE-1722**  
Blade  
0,12x5 mm  
Conf. 12 pcs



**DE-1723**  
Blade  
0,25x5 mm  
Conf. 12 pcs



**DE-1724**  
Blade  
0,25x3 mm  
Conf. 12 pcs



Behind Every Smile is a Story

- QUALITY - ЯКІСТЬ
- PRECISION - ТОЧНІСТЬ
- ACCURACY - ПРАВИЛЬНІСТЬ
- DURABILITY - ЗНОСОСТІЙКІСТЬ



- Super-sharp diamond-bonded cutters
- smooth ultra-polished and contoured edges
- brilliant corrosion resistant stainless steel finish
- superior 1-12 stainless steel tool inserts
- sliding lock joint for balance & precision alignment

- Super-sharp diamond-bonded cutters
- smooth ultra-polished and contoured edges
- brilliant corrosion resistant stainless steel finish
- superior 1-12 stainless steel tool inserts
- sliding lock joint for balance & precision alignment



STYLE A

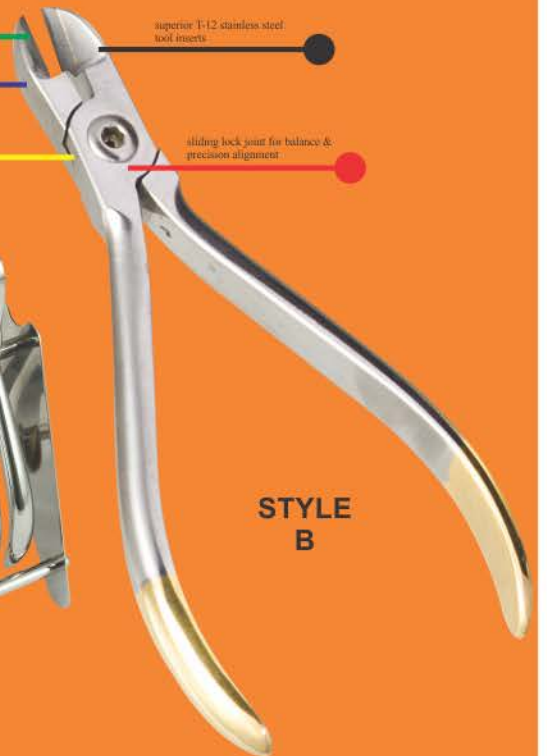

STYLE B

# ORTHODONTIC INSTRUMENTS



- Инструменты ортодонтические
- Instrumentos Ortodonticos
- Orthodontische Instrumente
- Инструменти ортодонтични
- Instruments Orthodontiques
- أدوات تقويم الأسنان



**DE-1800**  
Height Gauge 0.18  
Aluminum



**DE-1801**  
Height Gauge 0.22  
Aluminum



**DE-1802**  
Height Gauge 0.18  
Stainless Steel



**DE-1803**  
Height Gauge 0.22  
Stainless Steel



**DE-1804**  
Moveable  
Height Gauge



**DE-1805**  
Endo Finger  
Ruler Span  
Measure Scale



**DE-1806**  
Endo Finger  
Ruler Span  
Measure Scale



**DE-1807**  
Endo Finger  
Ruler Span  
Measure Scale



**DE-1808**  
Positive  
Postioner



**DE-1809**  
Strip Saw



**DE-1810**  
Bone Bracket Gauge



**DE-1811**  
Endo Finger Ruler  
Span Measure Scale



**DE-1812**  
Endo Finger Ruler  
Span Measure Scale



- Инструменты ортодонтические
- Instrumentos Ortodonticos
- Orthodontische Instrumente
- Инструменти ортодонтични
- Instruments Orthodontiques
- أدوات تقويم الأسنان



**DE-1813**  
Measuring Loop  
angled, length  
175 mm,  
measuring range  
0 - 40 mm



**DE-1814**  
Measuring Loop  
straight length  
175 mm,  
measuring range  
0 - 40 mm



**DE-1815**  
Measuring loop, Castroviejo  
angled, length 175 mm,  
measuring range 0 - 40 mm,  
with window



**DE-1816**  
Measuring Loop  
straight length 90 mm,  
measuring range  
0 - 40 mm,

**DE-1817**  
Castroviejo Calipers  
20mm  
90mm



**DE-1818**  
Measuring Loop  
angled, length 90 mm,  
measuring range  
0 - 40 mm,

**DE-1819**  
Castroviejo Calipers  
20mm, 45°  
90mm



**DE-1820**  
Castroviejo Calipers  
20mm  
90mm



**DE-1821**  
Fig. 1  
Iwanson  
spring caliper  
For metal and  
porcelain.



**DE-1822**  
Fig. 2  
Iwanson  
spring caliper  
For wax.

# ORTHODONTIC INSTRUMENTS



- Инструменты ортодонтические
- Instrumentos Ortodonticos
- Orthodontische Instrumente
- Инструменти ортодонтични
- Instruments Orthodontiques
- أدوات تقويم الأسنان



**DE-1823**  
Boley Gauge



**DE-1824**  
Vernier Gauge

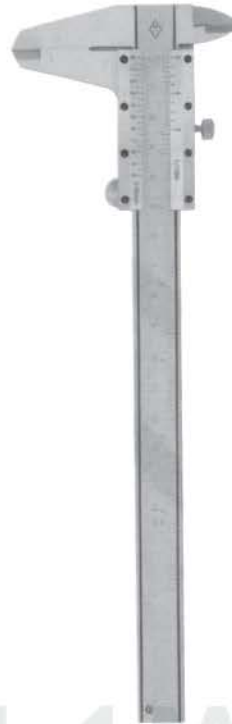

**DE-1825**  
Aluminium Caliper  
up to 200mm



**DE-1826**  
Boley Gauge



**DE-1827**  
Delux Boley  
Gauge



**DE-1828**  
Beerendonk  
130mm  
Mini Gauge



**DE-1829**  
Compasso  
De Willis



**DE-1830**  
Dentaurum  
Ruler



**DE-1831**  
Ruler Wedge



**DE-1832**  
Ruler



## ORTHODONTIC INSTRUMENTS

- Инструменты ортодонтические
- Instrumentos Ortodonticos
- Orthodontische Instrumente
- Инструменти ортодонтични
- Instruments Orthodontiques
- أدوات تقويم الأسنان

### Bracket Holder Tweezers



**DE-1833**  
Deluxe Bracket  
Holder Tweezers



**DE-1834**  
Deluxe Bracket  
Holder Tweezers



**DE-1835**  
Direct Bond Bracket  
Holder Tweezers



**DE-1836**  
Bracket Tweezers  
Slot Aligner



**DE-1837**  
Direct Bond  
Bracket Holder  
Tweezers, Small Tip



**DE-1838**  
Exact Bracket  
Holder Tweezers



**DE-1839**  
Bracket Placing  
Tweezers



**DE-1840**  
Easy Access  
Tweezers



**DE-1841**  
Bracket Placer  
Tweezers  
(Extra Fine Tip)



**DE-1842**  
Deluxe Bracket  
Holder Tweezers  
135mm



**DE-1843**  
Easy Eccess  
Tweezers



**DE-1844**  
Slipper  
Tweezers



**DE-1845**  
Direct Bonding  
Bracket Holders  
135mm



**DE-1846**  
Direct Bonding  
Bracket Holders  
136mm



**DE-1847**  
Direct Bonding  
Bracket Holders  
135mm



**DE-1848**  
Deluxe Bracket  
Holder



**DE-1849**  
Direct Bonding  
Bracket Holders  
140mm



# ORTHODONTIC INSTRUMENTS



- Инструменты ортодонтические
- Instrumentos Ortodonticos
- Orthodontische Instrumente
- Инструменти ортодонтични
- Instruments Orthodontiques
- أدوات تقويم الأسنان



**DE-1850**  
Band seater  
auto cleavable



**DE-1851**  
Band seater  
auto cleavable  
Triangle Shape



**DE-1852**  
Band seater  
auto cleavable  
Square Shape



**DE-1853**  
Band seater  
auto cleavable  
Round Shape



**DE-1854**  
Mershon Band  
Pusher  
140mm



**DE-1855**  
Band seating &  
removing  
instruments



**DE-1856**  
Ortho Light double  
ended  
ligature director  
scaler



**DE-1857**  
Ortho Light Band  
Pusher Scaler



**DE-1858**  
Band Seating &  
Removing  
Silicon Grip



**DE-1859**  
Ligature Instrument  
Silicon Grip



**DE-1860**  
Elastic Instrument  
Silicon Grip



**DE-1861**  
Distal Bender  
Silicon Grip



**DE-1862**  
Distal Bender  
Silicon Grip



**DE-1863**  
Distal Bender  
Silicon Grip



## ORTHODONTIC INSTRUMENTS

- Инструменты ортодонтические
- Instrumentos Ortodonticos
- Orthodontische Instrumente
- Инструменти ортодонтични
- Instruments Orthodontiques
- أدوات تقويم الأسنان



**DE-1864**  
Ortho light scaler double ended



**DE-1865**  
Ortho light scaler double ended



**DE-1866**  
Ortho light scaler double ended



**DE-1867**  
Twiel-on elastic module instrument



**DE-1868**  
Twiel-on elastic module instrument



**DE-1869**  
Schure Band Seater



**DE-1870**  
Ortho light scaler



**DE-1871**  
Ortho light scaler



**DE-1872**  
Ortho light scaler heavy



**DE-1873**  
Ortho instrument



**DE-1874**  
Ortho instrument

## ORTHODONTIC INSTRUMENTS



- Инструменты ортодонтические
- Instrumentos Ortodonticos
- Orthodontische Instrumente
- Инструменти ортодонтични
- Instruments Orthodontiques
- أدوات تقويم الأسنان



**DE-1875**  
Ortho Light double ended  
ligature director



**DE-1876**  
Ortho Light double ended ligature scaler director tivate coil spring  
are remove modules with one instruments



**DE-1877**  
Ortho band pusher scaler



**DE-1878**  
Ortho ligature director single ended



**DE-1879**  
Ortho Light double ended ligature  
director scaler



**DE-1880**  
Ortho Light double ended ligature scaler/director  
tivate coil spring are remove modules with one instruments



**DE-1881**  
Ortho Light double ended ligature director



**DE-1882**  
Ortholite Ligature Director Scaler



**DE-1883**  
Ortho light ligature director double ended



**DE-1884**  
Double ended cement spatula



**DE-1885**  
Ortho light scaler single ended





## PLIERS FOR ORTHODONTICS & PROSTHETICS

- Щипцы для ортодонтии и протезирования
- Pincers pour l'orthodontie et la prothèse
- Zangen für Kieferorthopädie und Prothetik
- Щипці для ортодонції та протезування
- Alicates para ortodoncia y prótesis
- كمانشة لتقويم الأسنان بروسثیتیس

### BOX JOINT PLIERS

**DE-1886**  
Universal Dolphin Style  
Wire Bending & cutting pliers



**DE-1892**  
Bracket Removing Plier curved  
Bracket Removing Plier curved for  
easy removal of brackets in the  
posterior region. Length 130mm



**DE-1887 Band Removing Plier**  
The curved blade of the band  
removing plier can strip easily  
and gently remove directly to  
the tooth. Length 130mm



**DE-1893**  
Young Wire Bending &  
Loop Forming Pliers



**DE-1888**  
Tweed Loop  
forming Pliers



**DE-1894**  
Wire Bending &  
Loop Forming Pliers



**DE-1889**  
How Plier curved  
Universally usable tool for  
the multiband technology for  
wires up to .028".  
Length 130mm



**DE-1895**  
Adams, small wire bending  
and loop forming Pliers



**DE-1890 How Plier**  
Universally usable tool for the  
multiband technology for wires  
up to .028".  
Length 135mm



**DE-1896**  
Bracket Removing Plier Round Box  
Bracket removing plier for comfortable  
and quick removal of the brackets.  
Length 135mm



**DE-1891**  
Nance Loop  
forming Pliers



**DE-1897**  
Weingart Plier medium  
Weingart plier that are ideal due to  
their curved tip for setting sheets and  
is capable of bending the ends.  
Length 145mm



# PLIERS FOR ORTHODONTICS & PROSTHETICS



- Щипцы для ортодонтии и протезирования
- Пинцес pour l'orthodontie et la prothèse
- Zangen für Kieferorthopädie und Prothetik
- Щипці для ортодонції та протезування
- Alicates para ortodoncia y prótesis
- كمامشة لتقويم الأسنان بروسثیتیس

## BOX JOINT PLIERS

### DE-1898 Adams Plier Round Box

Adams pliers for bending wire arches and bends right angles for wires up to .022", .025 tip to beak. Length 125mm



### DE-1904 Adams Plier

Adams pliers for bending wire arches and bends right angles for wires up to .022", .025 tip to beak. Length 125mm

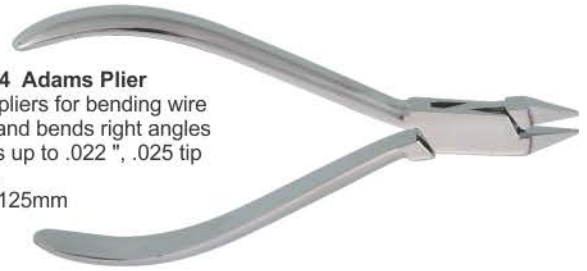

### DE-1899

Falcon Beak Contouring Pliers.



### DE-1905

Tweed Loop Formin Pliers



### DE-1900

wires up to 0.020" / 0.7mm.



### DE-1906 Bird Beak Plier Standard

Bird Beak Wire bending plier without notches, which is suitable as a universal utility tool. Length 125mm



### DE-1901

Johnson Contouring Pliers



### DE-1907

Mini Ligature cutters



### DE-1902 Aderer

Large wire bending and loop forming pliers



### DE-1908 Small

Fluch-cut distal and cutting Pliers with safety hold fitted with un-breakable, corrosion resistant and durable stainless steel tips



### DE-1903

Tweed / angle rectangular arch forming & Torquing pliers



### DE-1909 Large

Fluch-cut distal and cutting Pliers with safety hold fitted with un-breakable, corrosion resistant and durable stainless steel tips







## PLIERS FOR ORTHODONTICS & PROSTHETICS

- Щипцы для ортодонтии и протезирования
- Pincettes pour l'orthodontie et la prothèse
- Zangen für Kieferorthopädie und Prothetik
- Щипці для ортодонції та протезування
- Alicates para ortodoncia y prótesis
- كمانشة لتقويم الأسنان بروستھتیس

### BOX JOINT PLIERS

**DE-1910**

**Tweed / Angel**

1.78mm (.070") wide tips arch forming and torquing pliers



**DE-1916**

**Contouring Plier**



**DE-1911**

**Tweed / Angel**

1.78mm (.070") wide tips arch forming and torquing pliers



**DE-1917**

**Bands & Crowns Plier**  
in order to skirt



**DE-1912**

**Lingual / Palatal arch forming pliers**



**DE-1918**

**Ligature Forming Pliers**



**DE-1913**

**Aderer**

Facebow loop forming Pliers



**DE-1919**

for double back and triple back bands in 0.30" / 0.76mm & 0.36" / 0.91mm lingual arch wires



**DE-1914**

Waldsavhs wire bending and cutting pliers



**DE-1920**

**Bird Beak Wire Bending & cutting pliers**



**DE-1915 Aderer Plier**

For the manufacturing of appliances and activation of wires for wires up to .030" .fine tip and up to .036" mean tip.  
Length 130mm



**DE-1921**

**Weingart Plier medium**

Weingart plier that are ideal due to their curved tip for setting sheets and is capable of bending the ends.  
Length 145mm





# PLIERS FOR ORTHODONTICS & PROSTHETICS



- Щипцы для ортодонтии и протезирования
- Pincers pour l'orthodontie et la prothèse
- Zangen für Kieferorthopädie und Prothetik
- Щипці для ортодонції та протезування
- Alicates para ortodoncia y prótesis
- كمشة لتقويم الأسنان بروسثیتیس

## L-KEY JOINT PLIERS



**DE-1922**  
Distal end cutter with safety hold, mini head, long handles.  
fitted with un-breakable, corrosion resistant and durable stainless steel tips

- 0.30 mm to 0.50 mm (.012" to .020")
- Max. 0.46 mm x 0.64 mm (.018" x .025")
- ⊗ 0.38 mm to 0.53 mm (.0155" to .0215")
- ⊗ Max. 0.53 mm x 0.64 mm (.021" x .025")



**DE-1923**  
Flush-cut distal end cutter with safety hold fitted with un-breakable, corrosion resistant and durable stainless steel tips

- 0.30 mm to 0.50 mm (.012" to .020")
- Max. 0.46 mm x 0.64 mm (.018" to .025")



**DE-1924**  
Soft wire and ligature cutter, Mini fitted with un-breakable, corrosion resistant and durable stainless steel tips

- ☞ .25 mm to .38 mm (.010" to .015")



**DE-1925**  
Soft wire and ligature cutter, standard fitted with un-breakable, corrosion resistant and durable stainless steel tips

- ☞ .25 mm to .38 mm (.010" to .015")



**DE-1926**  
Soft wire and ligature cutter, 15° angled fitted with un-breakable, corrosion resistant and durable stainless steel tips

- ☞ .25 mm to .38 mm (.010" to .015")



**DE-1927**  
Soft wire and ligature cutter, 45° angled fitted with un-breakable, corrosion resistant and durable stainless steel tips

- ☞ .25 mm to .38 mm (.010" to .015")



**DE-1928**  
Hard wire cutter, straight Fitted with un-breakable, corrosion resistant and durable stainless steel tips

- 0.30 mm to 0.50 mm (.012" to .020")
- Max. 0.56 mm x 0.71 mm (.022" x .028")



**DE-1929**  
Hard wire cutter, 15° angled Fitted with un-breakable, corrosion resistant and durable stainless steel tips

- 0.30 mm to 0.50 mm (.012" to .020")
- Max. 0.56 mm x 0.71 mm (.022" x .028")



**DE-1930**  
Hard wire cutter, 15° angled Non-autoclavable

- 0.30 mm to 0.50 mm (.012" to .020")
- Max. 0.56 mm x 0.71 mm (.022" x .028")

- Щипцы для ортодонтии и протезирования
- Pincers pour l'orthodontie et la prothèse
- Zangen für Kieferorthopädie und Prothetik
- Щипці для ортодонції та протезування
- Alicates para ortodoncia y prótesis
- كمانشة لتقويم الأسنان بروتستيس

## L-KEY JOINT PLIERS



**DE-1931**  
Band removing pliers



**DE-1936**  
Weingart-mini  
Utility Pliers

- 0.30 mm to 0.50 mm (.012" to .020")
- Max 0.56 mm x 0.71 mm (.022" x .028")



**DE-1932**  
Bracket removing pliers angled



**DE-1937**  
Weingart  
Utility Pliers

- 0.30 mm to 0.50 mm (.012" to .020")
- Max 0.56 mm x 0.71 mm (.022" x .028")



**DE-1933**  
Bracket removing pliers straight



**DE-1938**  
How Straight  
Utility Pliers

- 0.30 mm to 0.50 mm (.012" to .020")
- Max 0.56 mm x 0.71 mm (.022" x .028")



**DE-1934**  
Bracket removing pliers with plastic tip



**DE-1939**  
Angled  
Utility Pliers

- 0.30 mm to 0.50 mm (.012" to .020")
- Max 0.56 mm x 0.71 mm (.022" x .028")

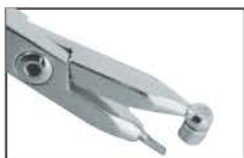

**DE-1935**  
Adhesive removing pliers



**DE-1940**  
Wire bending and loop forming pliers  
Angled (Bird beak)

- 0.30 mm to 0.50 mm (.012" to .020")
- Max 0.56 mm x 0.71 mm (.022" x .028")

# PLIERS FOR ORTHODONTICS & PROSTHETICS



- Щипцы для ортодонтии и протезирования
- Pincers pour l'orthodontie et la prothèse
- Zangen für Kieferorthopädie und Prothetik
- Щипці для ортодонції та протезування
- Alicates para ortodoncia y prótesis
- كمانشة لتقويم الأسنان بروستیتیس

## L-KEY JOINT PLIERS



**DE-1941**  
Multi-purpose pliers, bird beak,  
De la rosa and cutter in one

- 0.30 mm to 0.50 mm (.012" to .020")
- Max. 0.46 mm x 0.56 mm (.018" x .028")



**DE-1946**  
Stop pliers V-Bebd - 1mm

- 0.30 mm to 0.50 mm (.012" to .020")
- Max. 0.43 mm x 0.56 mm (.017" x .028")



**DE-1942**  
Cinch Back / tie back  
Distal end bending pliers

- 0.30 mm to 0.50 mm (.012" to .020")
- Max. 0.56 mm x 0.71 mm (.022" x .028")



**DE-1947**  
Lingual / palatal arch forming plies

- 0.76 mm (.030") / 0.91 mm (.036")



**DE-1943**  
Hammer head  
Distal end bending pliers

- 0.30 mm to 0.50 mm (.012" to .020")
- Max. 0.56 mm x 0.71 mm (.022" x .028")



**DE-1948**  
Torquing pliers set



**DE-1944**  
Nance  
Loop forming pliers

- 0.36 mm to 0.71 mm (.014" to .028")
- Max. 0.56 mm x 0.71 mm (.022" x .028")



**DE-1949**  
Tweed / angel  
Rectangular arch forming and  
torquing pliers

- 0.30 mm to 0.71 mm (.012" to .028")
- Max. 0.56 mm x 0.71 mm (.022" x .028")



**DE-1945**  
Detailing step pliers / Bayonet  
bending pliers - 1mm

- 0.30 mm to 0.50 mm (.012" to .020")
- Max. 0.56 mm x 0.71 mm (.022" x .028")



**DE-1950**  
Surgical ball hook crimping pliers,  
angled



**DE-1951**  
Surgical ball hook crimping  
pliers, straight





- Щипцы для ортодонтии и протезирования
- Pincettes pour l'orthodontie et la prothèse
- Zangen für Kieferorthopädie und Prothetik
- Щипці для ортодонції та протезування
- Alicates para ortodoncia y prótesis
- كمانشة لتقويم الأسنان بروستھتیس

## L-KEY JOINT PLIERS



**DE-1952**  
Aderer Clamp three jaw wire bending plier for contouring and bending wire up to .30"/.76mm.



**DE-1958**  
Falcon beak contouring plier.

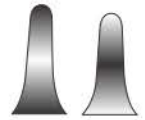

**DE-1953**  
Bird beak plier for bending round, square and rectangle wire up to .30"/.76mm.

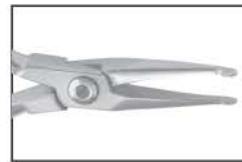
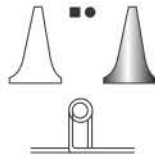

**DE-1959**  
For placement and removal of arch wires, pins and other auxiliaries.

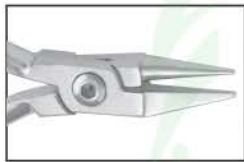

**DE-1954**  
Bird beak plier for light wire bending round, square and rectangular up to .016"/0.41mm.

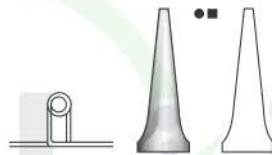

**DE-1960**  
For placement and removal of arch wires, pins and other auxiliaries in angle design.



**DE-1955**  
Double Rounded jaw bending pliers, hooks and wire up to .020"/0.51mm.

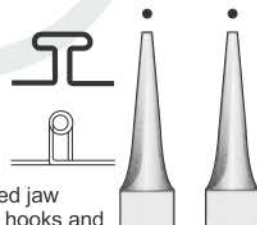

**DE-1961**  
contouring Plier.



**DE-1962**  
Bending plier. In order to skirt molars bands. With grooved. Recommended wire. 016", 018" and 022" 0.41mm, 0.46mm and 0.56mm



**DE-1956**  
Adams pliers for hooks and bending wire up to .030"/0.76mm.

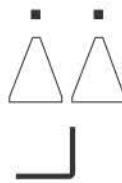

**DE-1963**  
Loop forming in four length 3, 4, 5 & 6 mm wire capacity 0.22", 56mm.

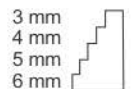

**DE-1957**  
Johnson pliers for crown band contouring



**DE-1964**  
Arch bending plier design for convenient handling of square or rectangular wire, .020" / 0.51mm.



# PLIERS FOR ORTHODONTICS & PROSTHETICS



- Щипцы для ортодонтии и протезирования
- Pincers pour l'orthodontie et la prothèse
- Zangen für Kieferorthopädie und Prothetik
- Щипці для ортодонції та протезування
- Alicates para ortodoncia y prótesis
- كماشة لتقويم الأسنان بروستيتيس

## LAP & L-KEY JOINT PLIERS

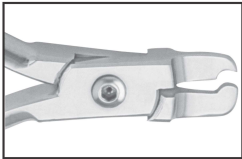

**DE-1965**  
In order to skirt bands and crowns.

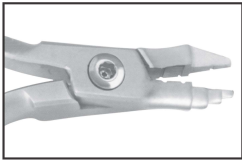

**DE-1966**  
Wires up to .020" / 0.7mm.

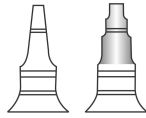

**DE-1967**  
Round and concave plier for loop forming and banding wire up to .20" / .051mm.

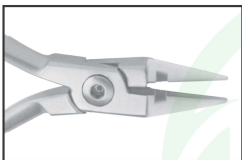

**DE-1968**  
Bending for round square or rectangular wire up to 0.30"/0.76mm

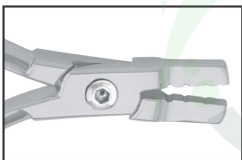

**DE-1969**  
for double back and triple back bands in 0.30" / .76mm & 0.36" / .91mm lingual arch wires.

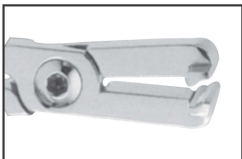

**DE-1970**  
Detailing step plier double-sided offset beak permits bayonet bends. Creates right hand or left hand step-up or stepdown at 1/2, 3/4, or 1mm increments.

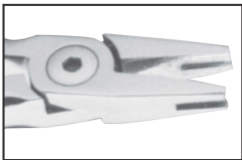

**DE-1971**  
"V" bend stop special design makes 1mm "v" bends to shorten archwires or provide a positive stop. Excellent for placing stops in titanium wires. For round or rectangular wires up to .025"



**DE-1972**  
Angle how plier efficient utility plier with serrated beaks for a firm grip. 45 angled tips to access hard to reach areas.



**DE-1973**  
Weingardt plier serrated tips hold wires firmly at a convenient working angle. Tapered beaks fit easily between brackets and hard to reach areas. Our most popular utility plier.



**DE-1974**  
Pin & Ligature Cutters TC.



**DE-1975**  
Mini Pin & Ligature Cutter TC.



**DE-1976**  
Standard Ligature Cutter TC.



**DE-1977**  
V Bend Stop Plier TC.



**DE-1978**  
Angled Direct Bond Bracket Remover TC.



**DE-1979**  
Cutter Str.



Distal Cutter  
14cm  
**DE-1980** 2.5 mm  
**DE-1981** 3.0 mm  
**DE-1982** 3.0 mm

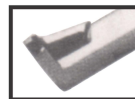

**DE-1983**  
Arrow Clasp Forming Pliers  
12.0cm



**DE-1984**  
Schwarz  
12.5cm





# DISTAL END, WIRE CUTTERS & BRACKET REMOVER PLIERS

**DE-1985**  
Distal end Cutter, Safety Hold Plier  
(Ideal for Cutting Wire) TC.



**DE-1986**  
Hook Crimping Plier Angled  
Straight TC.



**DE-1987**  
3 Prong Clasp Adjustable  
Plier TC.



**DE-1988**  
Utility Plier Weingart TC.



**DE-1989**  
Direct Bracket Remover  
TC.



**DE-1990**  
Straight Direct Bond Bracket  
Remover TC.



**DE-1991**  
Pin Holding Plier TC.



**DE-1992**  
Hard wire cutters



**DE-1993**  
Elastic Separating Plier  
Round Handle

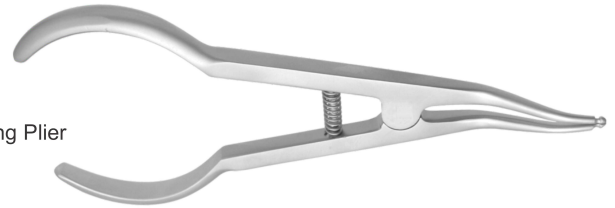

**DE-1994**  
Elastic  
Separating Plier

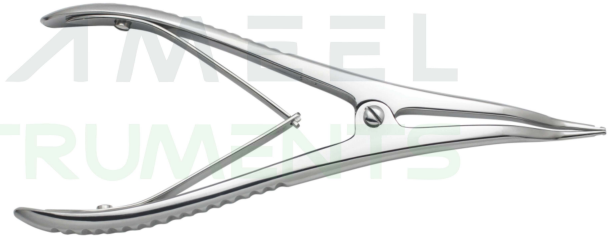

**DE-1995 Str.**  
**DE-1996 Cvd.**  
Smaha  
Elastomeric  
ligature  
placing forceps  
140 mm



**DE-1997**  
Elastomeric  
ligature placing  
forceps with  
groove  
Falcon 140 mm

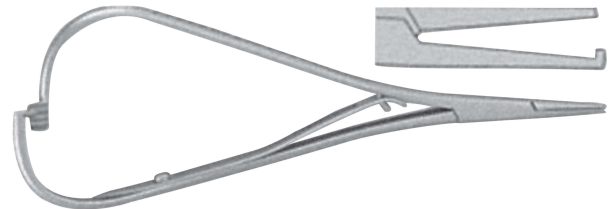

**DE-1998**  
Elastomeric  
ligature placing  
forceps with  
groove  
Falcon 140 mm

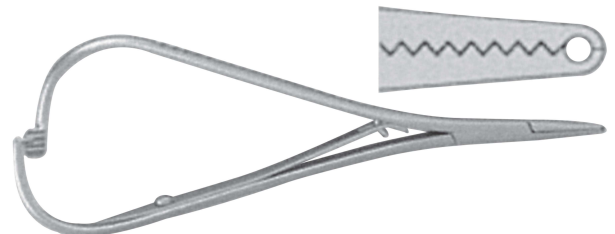



# PLIERS FOR ORTHODONTICS & PROSTHETICS



- Щипцы для ортодонтии и протезирования
- Pincas pour l'orthodontie et la prothèse
- Zangen für Kieferorthopädie und Prothetik
- Щипці для ортодонції та протезування
- Alicates para ortodoncia y prótesis
- كماشة لتقويم الأسنان بروستیتیس

## CUTTER, UTILITY PLIERS & WIRE FORMING PLIERS



**DE-1999**  
Weingart Pliers



**DE-2004**  
Adhesive  
Removing Pliers



**DE-2000**  
Slim Weingart  
Pliers



**DE-2005**  
Posterior Band Removing  
Pliers - Long



**DE-2001**  
How Pliers  
Straight



**DE-2006**  
Posterior Band Removing  
Pliers - Short

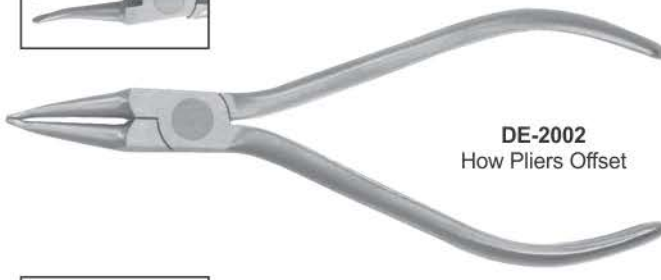

**DE-2002**  
How Pliers Offset

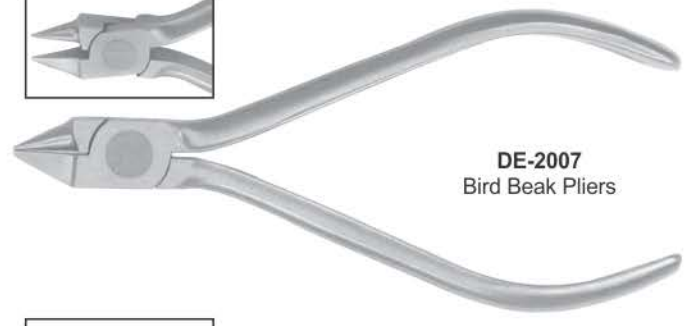

**DE-2007**  
Bird Beak Pliers

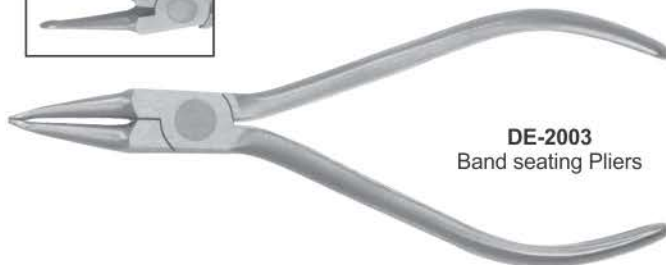

**DE-2003**  
Band seating Pliers

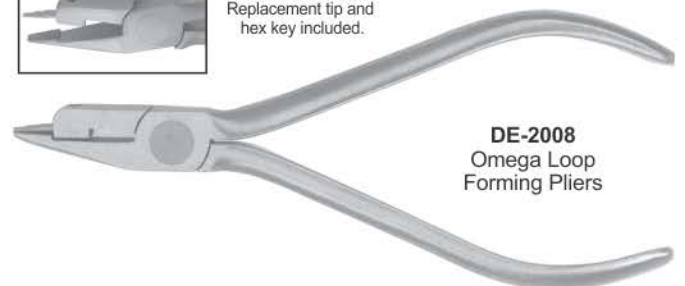

Replacement tip and  
hex key included.

**DE-2008**  
Omega Loop  
Forming Pliers



## PLIERS FOR ORTHODONTICS & PROSTHETICS

- Щипцы для ортодонтии и протезирования
- Pincers pour l'orthodontie et la prothèse
- Zangen für Kieferorthopädie und Prothetik
- Щипці для ортодонтії та протезування
- Alicates para ortodoncia y prótesis
- كمانشة لتقويم الأسنان بروستیتیس

### CUTTERS



**DE-2009**  
Hard  
Wire Cutter 15



**DE-2013**  
Mini Pin &  
Ligature Cutter



**DE-2010**  
Distal End Cutter  
Flush Cut



**DE-2014**  
Hard Wire Cutter  
Straight



**DE-2011**  
Universal Cut & Hold  
Distal End Cutter



**DE-2015**  
Micro-Mini Pin &  
Ligature Cutter



**DE-2012**  
Pin & Ligature  
Cutter



**DE-2016**  
Cutter

## PLIERS FOR ORTHODONTICS & PROSTHETICS



- Щипцы для ортодонтии и протезирования
- Pincas pour l'orthodontie et la prothèse
- Zangen für Kieferorthopädie und Prothetik
- Щипці для ортодонтії та протезування
- Alicates para ortodoncia y prótesis
- كماشة لتقويم الأسنان بروستیتیس



**DE-2017**  
Three Jaw Pliers

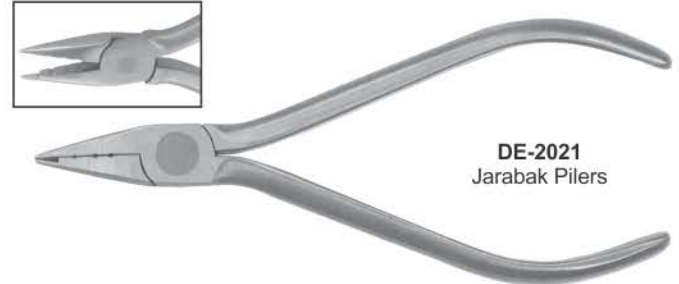

**DE-2021**  
Jarabak Pliers



**DE-2018**  
Light Wore Bird Beak  
Pliers with Groove



**DE-2022**  
Hollow Chop  
Contouring Pliers



**DE-2019**  
Tweed loop  
Forming Pliers

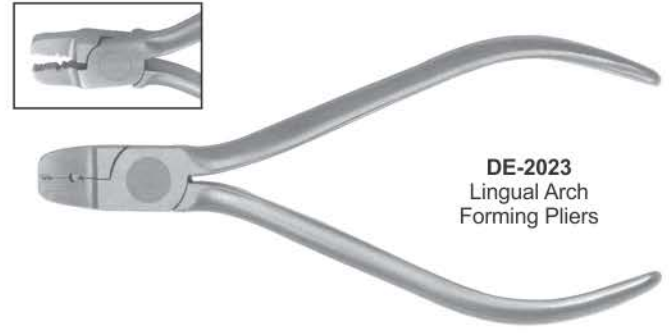

**DE-2023**  
Lingual Arch  
Forming Pliers

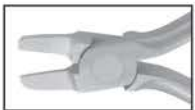

**DE-2020**  
Arch Bending Pliers

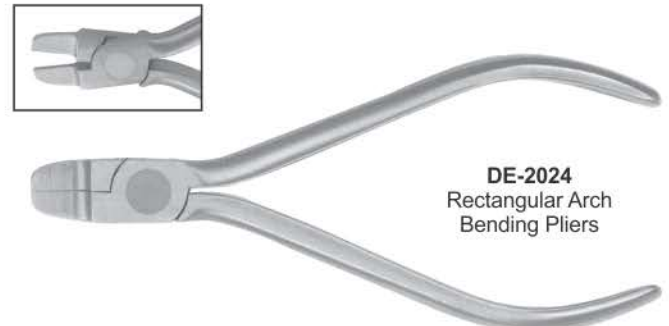

**DE-2024**  
Rectangular Arch  
Bending Pliers





## ORTHODONTICS PLIERS STANDS

- Ортодонтия Щипцы Подставки
- Supports de pinces d'orthodontie
- Kieferorthopädie Zangenständer
- Ортодонтия Щипці Підставки
- KFO Zangen Ständer
- تقويم الأسنان كماشة تقف



**DE-2025**  
Plier Stand  
Stainless Steel.



**DE-2026**  
Plier Stand  
Stainless Steel.



**DE-2027**  
Pliers Stand  
Stainless Rod  
(Aluminum Anodized)  
Stainless Steel



**DE-2028**  
Plier Stand  
Stainless Steel.



**DE-2029**  
Plier Stand  
Stainless Steel.



**DE-2030**  
Plier Stand  
Plastic

# Normal Anatomy – Dental Implants

Bone Level Normal  
(No Bone Loss)

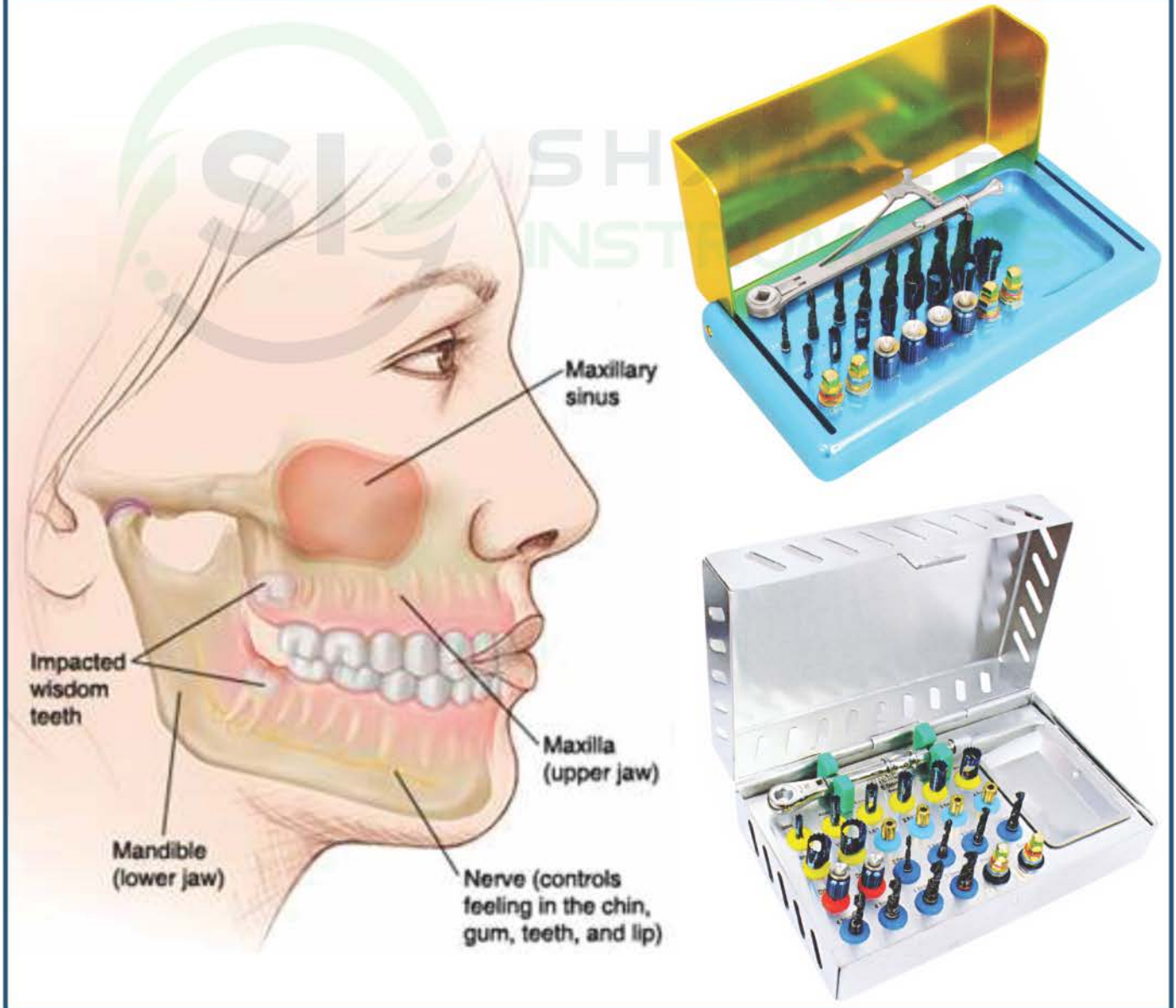
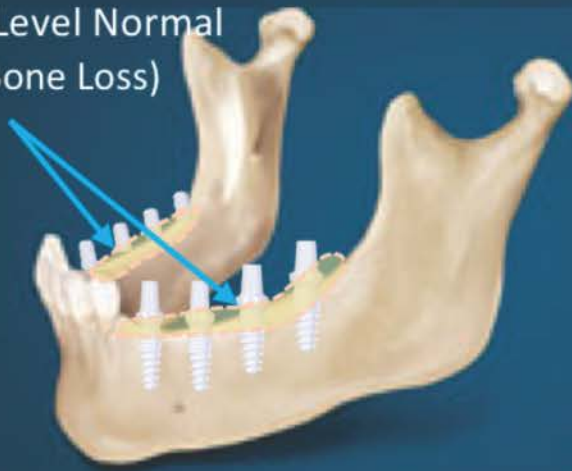

- Инструменты для имплантологии
- Implantologie
- Implantologie
- Инструменти для імплантології
- Implantologia
- زراعة الأسنان

## IMPLANT GAGES



**DE-2100**  
**Multifunctional Meter**  
 Length 90 mm,  
 different sizes,  
 8-10-11mm,  
 corrosion-resistant

**DE-2101**  
**Multifunctional Meter**  
 Length 90 mm,  
 different sizes,  
 5-13-15-17 mm,  
 corrosion-resistant

**DE-2102**  
**Measuring Probe**  
 Length 170 mm,  
 hand shape or flexible  
 (6-8-10-14-16 mm),  
 corrosion-resistant

**DE-2103**

**DE-2104**

**DE-2105**

**DE-2106**

## IMPLANT GAGES



**DE-2107**

**DE-2108**

**DE-2109**



# IMPLANTOLOGY



- Инструменты для имплантологии
- Implantologie
- Implantologie

- Инструменти для імплантології
- Implantologia
- زراعة الأسنان



**DE-2110**  
Ridge Mapping  
Double Caliper



**DE-2111**  
Bone Thickness Gauge  
40mm, 180mm



**DE-2112**  
Osteometer  
Measuring Forceps For Jaw  
Ridge Width measurement, scale  
on both sides, rustfree, autoclavable

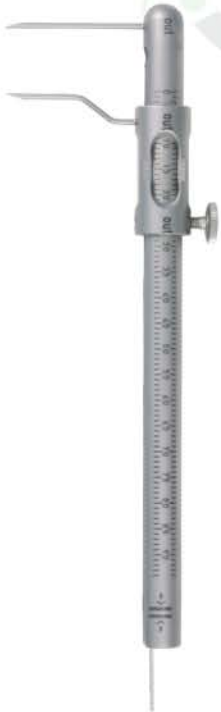

**DE-2113**  
Micro Boley  
Gauge Twisted



**DE-2114**  
Micro Boley  
Gauge Straight



**DE-2115**  
Ortho Ruler / Cone Socket

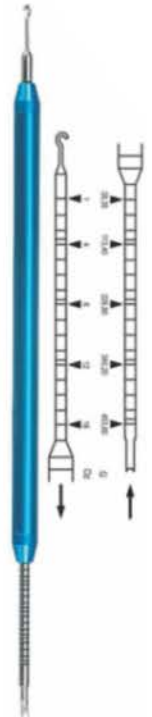

**DE-2116**  
Dynamometer



## IMPLANTOLOGY

- Инструменты для имплантологии
- Implantologie
- Implantologie
- Инструменти для імплантології
- Implantologia
- زراعة الأسنان

### BLACK TITANIUM COLOUR COATED INSTRUMENTS



# IMPLANTOLOGY



- Инструменты для имплантологии
- Implantologie
- Implantologie
- Инструменти для імплантології
- Implantologia
- زراعة الأسنان

## BLACK TITANIUM COLOUR COATED INSTRUMENTS



**DE-2125**  
A  
Cosmetic  
Contouring

**DE-2126**  
B  
Cosmetic  
Contouring

**DE-2127**  
C  
Cosmetic  
Contouring

**DE-2128**  
D  
Cosmetic  
Contouring

**DE-2129**  
F  
Cosmetic  
Contouring

**DE-2130**  
Marginal Ridge  
& Embrasure  
Shaping Instrument

**DE-2131**  
Occlusal  
Anatomy  
Instrument





## IMPLANTOLOGY

- Инструменты для имплантологии
- Implantologie
- Implantologie
- Инструменти для імплантології
- Implantologia
- زراعة الأسنان

### BLACK TITANIUM COLOUR COATED INSTRUMENTS

#### BURNISHERS

#### FREEDMAN BURNISHERS



DE-2132  
21B



DE-2133  
27/29



DE-2134  
2  
Ladmore



DE-2135  
3  
Ladmore



DE-2136  
Freedman  
"Duckhead"



DE-2137  
Freedman  
Small Contact  
Forming



DE-2138  
Freedman  
Large Contact  
Forming



DE-2139  
Small/  
Medium Ball  
Burnisher

# IMPLANTOLOGY



- Инструменты для имплантологии
- Implantologie
- Implantologie
- Инструменти для імплантології
- Implantologia
- زراعة الأسنان

## SINUS LIFT INSTRUMENTS HOLLOW HANDLE 9.5MM LENGTH 170MM

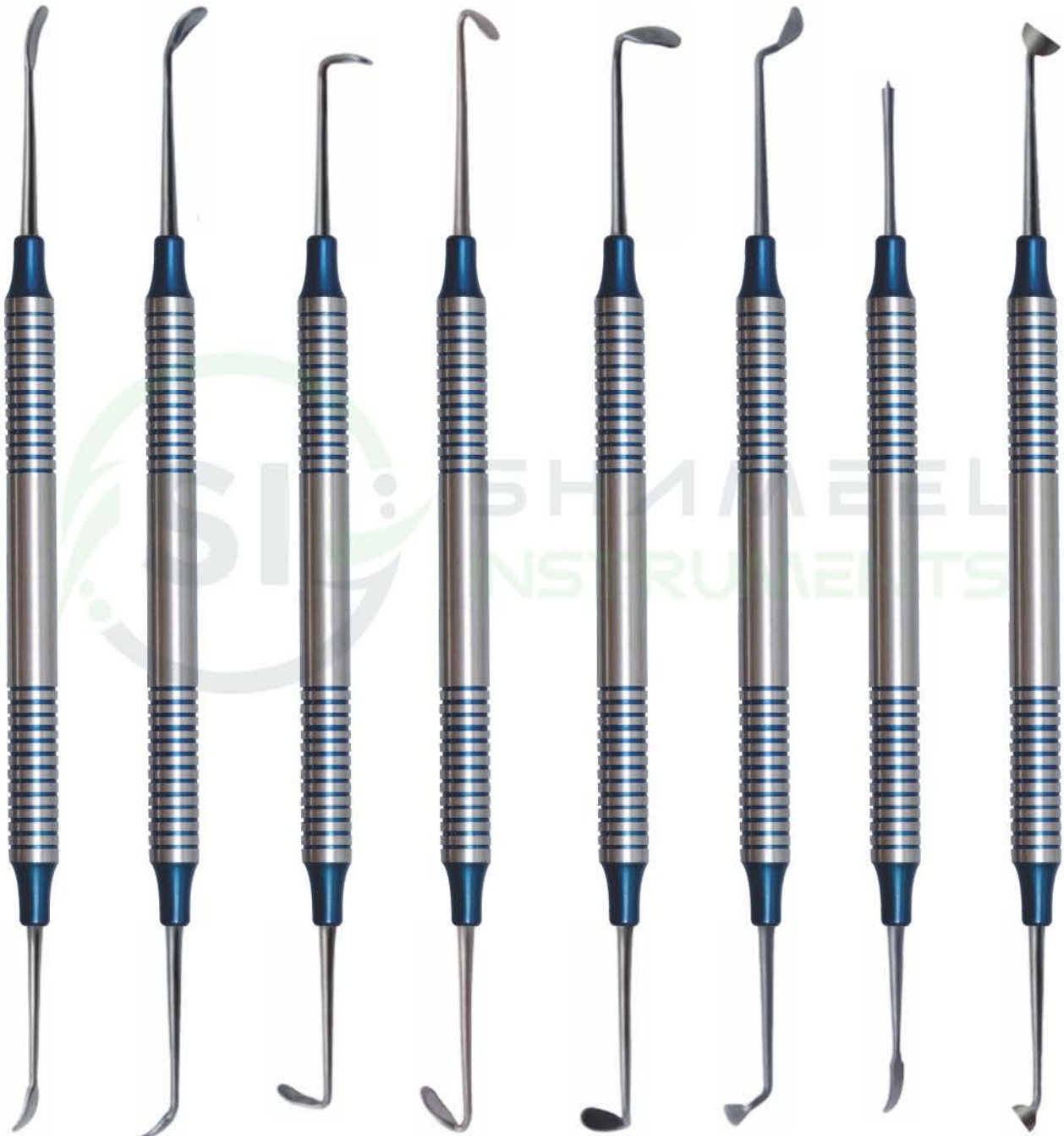

DE-2140  
Sinuslift 1

DE-2141  
Sinuslift 2

DE-2142  
Sinuslift 3

DE-2143  
Sinuslift 4

DE-2144  
Sinuslift 5

DE-2145  
Sinuslift 6

DE-2146  
Membrane  
3Positioning 1

DE-2147  
Condenser 1



## IMPLANTOLOGY

- Инструменты для имплантологии
- Implantologie
- Implantologie
- Инструменти для імплантології
- Implantologia
- زراعة الأسنان

**Sinus Lift Instrument,**  
Flexible Sinus Lift instruments  
reduce the risk of perforation of the  
"Schneider's membrane"

**Sinus Lift Elevator,**  
10 mm Straight grip  
Length 175 mm, Sinus lift elevators, dull,  
for gentle peeling and lifting the  
Schneider membrane

**Sinus lift instrument**  
10 mm Straight grip Length 180 mm,  
Buser (B1, B2, B3) raspatories,  
quality medical stainless steel,  
corrosion-resistant



DE-2148  
Fig. 1

DE-2149  
Fig. 2

DE-2150  
Fig. 3



DE-2151  
Fig. 1

DE-2152  
Fig. 2

DE-2153  
Fig. 3



DE-2154  
B01

DE-2155  
B02

DE-2156  
B03



# IMPLANTOLOGY



- Инструменты для имплантологии
- Implantologie
- Implantologie
- Инструменти для імплантології
- Implantoloia
- زراعة الأسنان

**Sinus lift instrument** 10 mm Straight grip Sinus lift elevators, blunt or sharply curved (H01, H02, K03, K04, K78, K77)

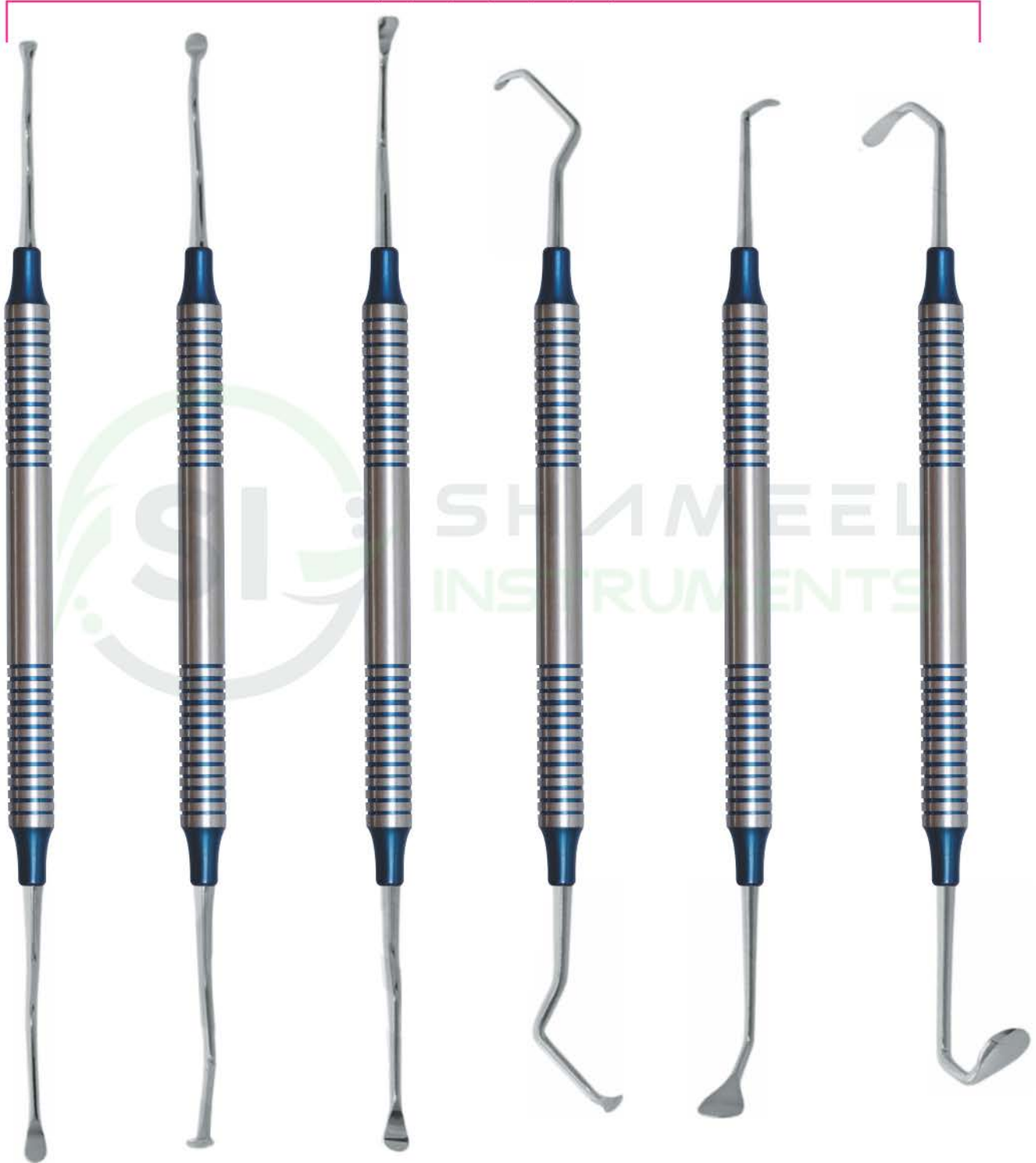

**DE-2157**  
Sinus lift  
instrument  
H01

**DE-2158**  
Sinus lift  
instrument  
H02

**DE-2159**  
Sinus lift  
instrument  
K03

**DE-2160**  
Sinus lift  
instrument  
K04

**DE-2161**  
Sinus lift  
instrument  
K78

**DE-2162**  
Sinus lift  
instrument  
K77



## IMPLANTOLOGY

- Инструменты для имплантологии
- Имплантология
- Имплантология
- Инструменти для імплантології
- Implantologia
- زراعة الأسنان

### Composite Filling Instruments Set of 6 Pcs



DE-2163



DE-2164



DE-2165



DE-2166



DE-2167



DE-2168

#### COMPOSITE INSTRUMENTS USE:

A composite (tooth colored) filling is used to repair a tooth that is affected by decay, cracks, fractures, etc. The decayed or affected portion of the tooth will be removed and then filled with a composite filling.

There are many types of filling materials available, each with their own advantages and disadvantages. You and your dentist can discuss the best options for restoring your teeth. Composite fillings, along with silver amalgam fillings, are the most widely used today. Because composite fillings are tooth colored, they can be closely matched to the color of existing teeth, and are more aesthetically suited for use in front teeth or the more visible areas of the teeth.

As with most dental restorations, composite fillings are not permanent and may someday have to be replaced. They are very durable, and will last many years, giving you a long lasting, beautiful smile.



Procedure: Composite filling Anterior

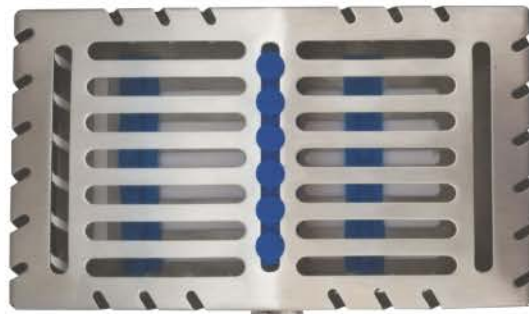

DE-2169

# IMPLANTOLOGY



- Инструменты для имплантологии
- Implantologie
- Implantologie
- Инструменти для імплантології
- Implantologia
- زراعة الأسنان

Set of 5 Composite Gold Tip Instruments  
DE-2170

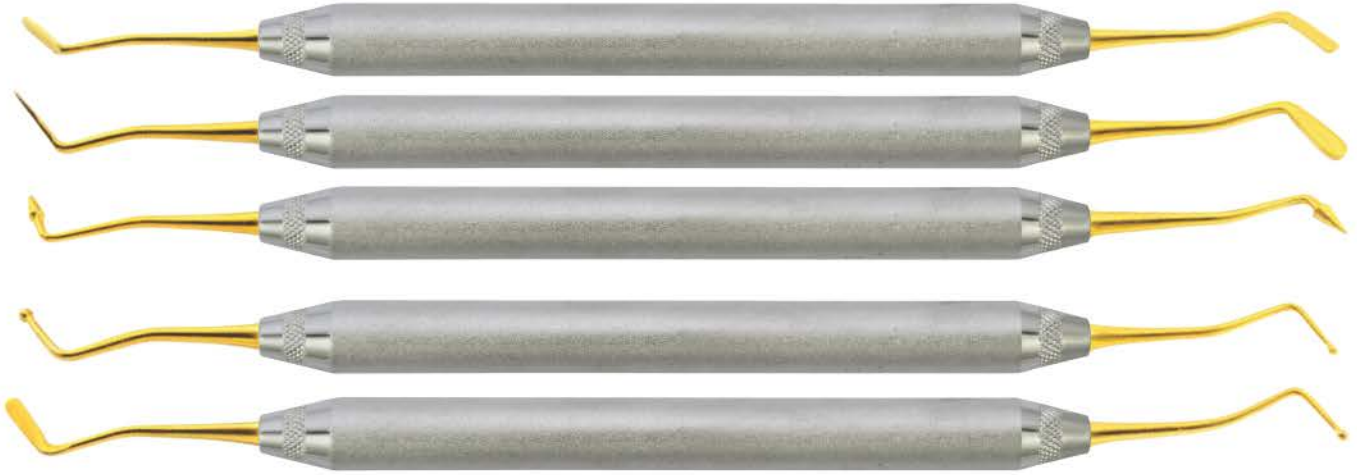

Set of 4 Composite Blue Tip Instruments  
DE-2171



Set of 3 Composite Blue Tip Instruments  
DE-2172



Set of 2 Composite Blue Tip Instruments  
DE-2173



DE-2174 Periosteal Elevators Molt # 9

DE-2175 Endodontic explorer DG # 16





## IMPLANTOLOGY

- Инструменты для имплантологии
- Implantologie
- Implantologie
- Инструменти для імплантології
- Implantologia
- زراعة الأسنان

### VISTA TUNNELING INSTRUMENTS SET



DE-2176



DE-2177



DE-2178



DE-2179



DE-2180



DE-2181



DE-2182



# IMPLANTOLOGY



- Инструменты для имплантологии
- Implantologie
- Implantologie

- Инструменти для имплантології
- Implantologia
- زراعة الأسنان



**DE-2183**  
used for elevation of sinus membrane



**DE-2184**  
used for elevation of sinus membrane

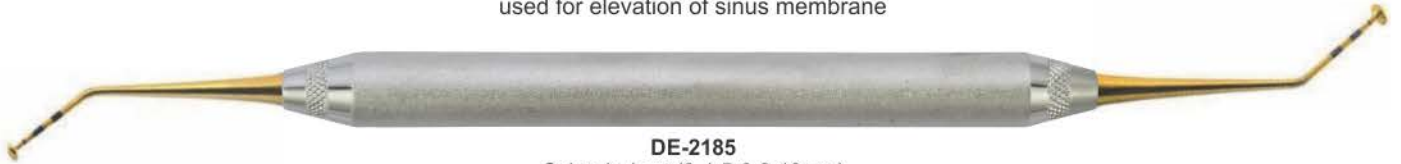

**DE-2185**  
Cobra in / out (2-4-5-6-8-10mm)



**DE-2186**  
Cobra 3.5mm



**DE-2187**  
sinus 4.8 / 5.8 (2-4-5-6-8-10mm)



**DE-2188**  
sinus 2.8 / 3.8 (2-4-5-6-8-10mm)



**DE-2189**  
Bone Graft 3.8SP / 2.8mm (2-4-5-6-8-10mm)



**DE-2190**  
Cobra in / out (2-4-5-6-8-10mm)



**DE-2191**  
Cobra 3.5mm



**DE-2192**  
Gold Color Set Dental Oral Implantology Sinus Set of 10 Pcs with cassette



## IMPLANTOLOGY

- Инструменты для имплантологии
- Implantologie
- Implantologie
- Инструменти для імплантології
- Implantologia
- زراعة الأسنان



**DE-2193**  
Sinus Lift elevator 1



**DE-2194**  
Sinus Lift elevator 2



**DE-2195**  
Sinus Lift elevator 3



**DE-2196**  
Sinus Lift elevator 4



**DE-2197**  
Sinus Lift elevator 5



**DE-2198**  
Sinus Lift elevator 6



**DE-2199**  
Sinus Lift Elevators Set of 7 Pcs  
with cassette



# IMPLANTOLOGY



- Инструменты для имплантологии
- Implantologie
- Implantologie
- Инструменти для імплантології
- Implantologia
- زراعة الأسنان

## Sinus Left Elevator Set of 10 Pcs





## IMPLANTOLOGY

- Инструменты для имплантологии
- Implantologie
- Implantologie
- Инструменти для імплантології
- Implantologia
- زراعة الأسنان

### Blue Titanium Coated Bone Grafting Instruments



**DE-2210**

Bone Graft 1.0 / 1.7 mm Titanium 8. 11. 13. 15. 18 mm



**DE-2211**

Bone Graft 1.0 / 2.0 mm Titanium 8. 11. 13. 15. 18 mm



**DE-2212**

Bone Graft 2.4 / 2.7 mm Titanium 8. 11. 13. 15. 18 mm



**DE-2213**

Bone Graft 3.3 / 4.0 mm Titanium 8. 11. 13. 15. 18 mm



**DE-2214**

Bone Graft 3.3 / 4.0 mm Titanium Coated Tips



**DE-2215**

Bone Graft / Carrier Titanium 8. 11. 13. 15. 18 mm

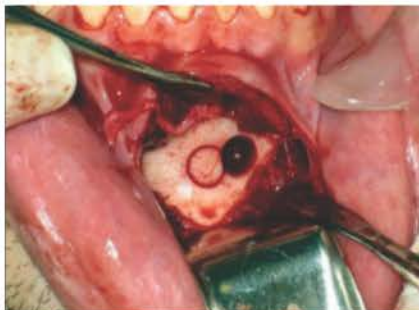

**DE-2216**

Blue Titanium Coated Bone Grafting Instruments Set of 7 Pcs with cassette

- Инструменты для имплантологии
- Implantologie
- Implantologie

- Инструменти для імплантології
- Implantoloia
- زراعة الأسنان



DE-2217  
Fig. 1



With curette the sinus membrane is further detached over a broad area in the inner region, especially along the roof of the palate.



DE-2218  
Fig. 2



DE-2219  
Fig. 3



DE-2220  
Fig. 4



DE-2221  
Fig. 5



DE-2222  
Fig. 6



DE-2223

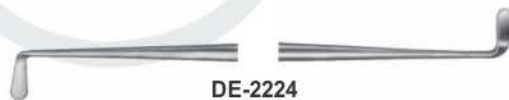

DE-2224

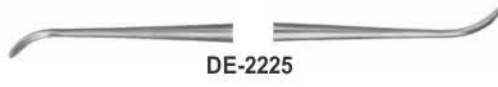

DE-2225



DE-2226



DE-2227



### Flexible Sinus-Lift Curettes – for an optimum sensitivity during the direct lift procedure

The perforation of the Schneiderian membrane is a complication that often occurs during a maxillary sinus floor augmentation procedure. The Sinus-Lift Instruments increase the sensitivity by blunt and flexible working tips with "Swing-Effect". Because of their special shapes and the characteristic of the stainless steel between the handle and the active part, light pressure is cushioned and gives the operator a direct and sensitive response. At the same time the risk to perforate the Schneiderian membrane is reduced to a minimum. Already at the development the focus was a practicable handling. Because of varying angulations and shapes of the active parts also in difficult areas they are easy to navigate also in difficult areas. The line of curettes consists of six different figures for every situation. They are complemented by spoon and condenser to place the bone graft.



The "Schneider's Membrane" of the sinus can be detached with curette by 1–2mm along the total cortical bone.



Curette is particularly useful in the lower part for detaching the membrane further. The same goes for the caudal area, especially when the membrane is 4–5 mm above the base of the maxillary sinus and the maxillary sinus is built up with granular material.



Curette makes it possible to lift the membrane further in mesial region. One working tip is especially designed for the right maxillary sinus and the other for the left maxillary sinus.



With curette the sinus membrane is further elevated in the upper and posterior part of the maxillary sinus wall.





# IMPLANTOLOGY

- Инструменты для имплантологии
- Implantologie
- Implantologie
- Инструменти для імплантології
- Implantologia
- زراعة الأسنان

## IMPLANT SINUS LIFT INSTRUMENTS HOLLOW HANDLE 9.5MM LENGTH 170MM

## SINUS LIFT INSTRUMENTS HOLLOW HANDLE 9.5MM LENGTH 170MM



9 Pcs of Set  
DE-2236



9 Pcs of Set  
DE-2245

# IMPLANTOLOGY



- Инструменты для имплантологии
- Implantologie
- Implantologie

- Інструменти для імплантології
- Implantoloia
- زراعة الأسنان

## IMPLANT SINUS LIFT INSTRUMENTS PERIODONTAL SURGERY SURGICAL CHISELS KRAMER NEVINS SINUS LIFT

## SURGICAL CHISELS



DE-2246  
TG



DE-2247 SOLT3/4



DE-2248 TGO



DE-2249 OCH3



DE-2250 OCH4



DE-2251 FEDI1



DE-2252 FEDI2



DE-2253 FEDI3



3.5mm

DE-2254 13K/TG

3mm



3.5mm

DE-2255  
13K/TG Titanium

3mm



3.5mm

DE-2256 13K/TG

4.5mm



3.5mm

DE-2257  
13KL/R Titanium

4.5mm



4mm

DE-2258 13KL 4/6mm  
Titanium Available

6mm



DE-2259  
Cassette For Instruments



## IMPLANTOLOGY

- Инструменты для имплантологии
- Implantologie
- Implantologie
- Инструменти для імплантології
- Implantologia
- زراعة الأسنان

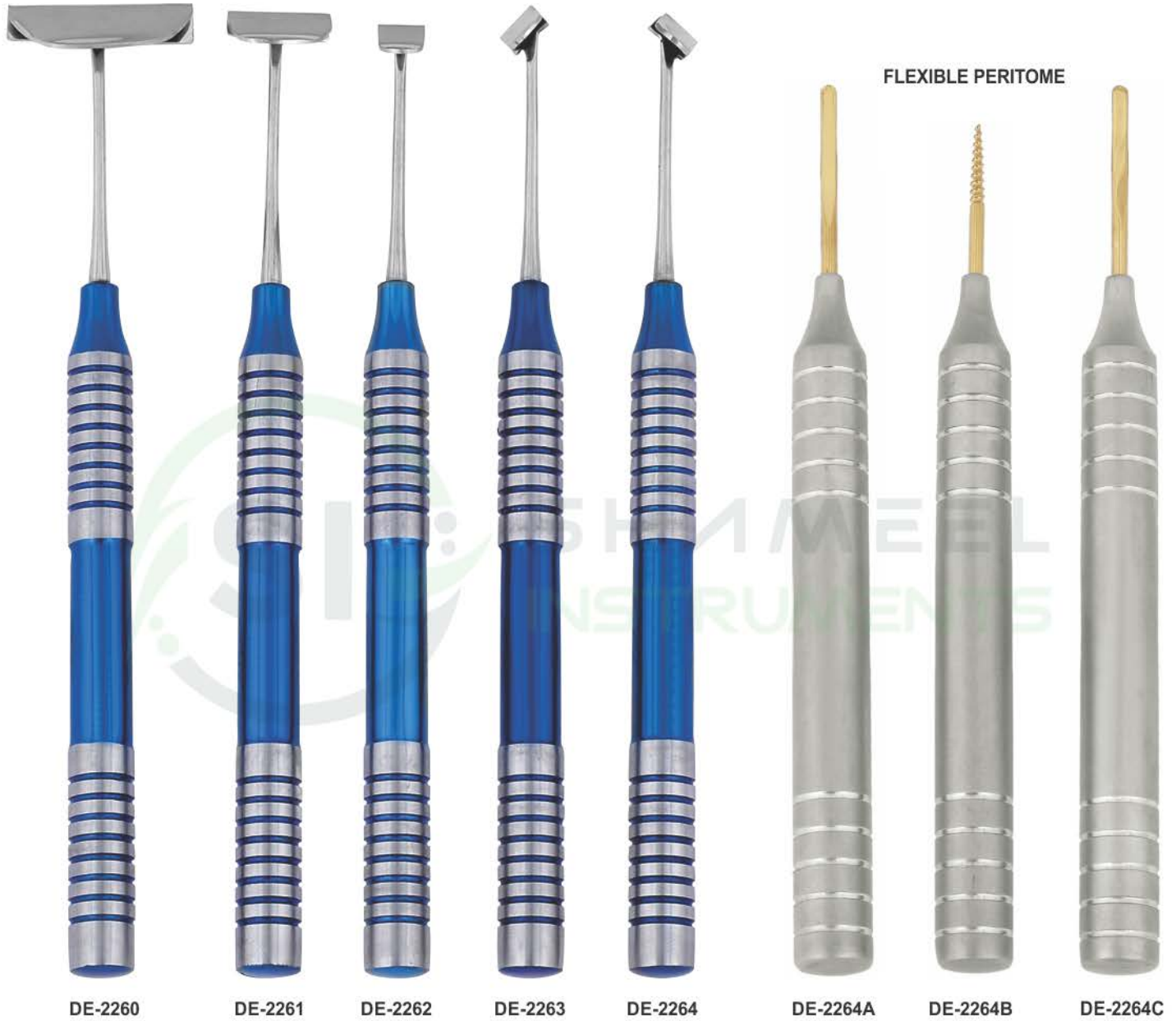

Soft Brushing Kit Set of 6 Pcs





# IMPLANTOLOGY



- Инструменты для имплантологии
- Implantologie
- Implantologie

- Инструменти для імплантології
- Implantologia
- زراعة الأسنان

## SINUS ELEVATOR & MEMBRANE LIFT TIPS



**DE-2265**  
Membrane Detach Elevator



**DE-2266**  
Membrane Elevator



**DE-2267**  
Membrane Elevator



**DE-2268**  
Membrane Elevator



**DE-2269**  
Membrane Elevator



**DE-2270**  
Bone Graft Packer



**DE-2270A** Pt2 Titanium  
A/V Regular



**DE-2270B** Pt1 Titanium  
A/V Regular



**DE-2270C** Pt3 Titanium Angel S/E



**DE-2270D** Pt4 Titanium STR S/E



**DE-2270E** Pt5 Titanium TG CVD S/E



**DE-2271**  
Sinus Left Elevator & Membrane Lift Tips  
set of 7 Pcs

- Инструменты для имплантологии
- Implantologie
- Implantologie
- Инструменти для імплантології
- Implantologia
- زراعة الأسنان

## MIXING SPATULA WITH SHOVEL



**DE-2272**  
Bone Carrier  
Titanium



**DE-2273**  
Raspator, Prichard  
Length 180 mm,  
10 mm hollow handle,  
double-ended  
10.5 mm | 4.5 mm,



**DE-2274**  
Raspator, Prichard  
Length 180 mm,  
10 mm hollow handle,  
double ended



**DE-2275**  
Raspator, Prichard  
Length 180 mm,  
10 mm hollow handle,  
double-ended  
10.5 mm | 4.5 mm,



**DE-2276**  
Mixing Spatula  
with shovel  
17cm



**DE-2277**  
Mixing Spatula  
with shovel  
18.5cm



**DE-2278**  
Graft Material Spoon  
Concave Tip For  
Larger Grafts

# IMPLANTOLOGY



- Инструменты для имплантологии
  - Implantologie
  - Implantologie
- Инструменти для имплантології
  - Implantologia
  - زراعة الأسنان

**BONE GRAFTING INSTRUMENTS COMPACTOR /TAMPERS**

Product offering includes instruments for harvesting, mixing and compacting bone Provides clinicians with the proper instrumentation for bone grafting procedures Weighted bone basin Prevents tipping and spilling of bone and other materials during mixing



**DE-2279**  
Graft Packer, Concave Tips DE 4/6mm



**DE-2280**  
Bone Spoon/ Packer DE 3mm



**DE-2281**  
Blade and pusher Length 180 mm, for straight or angled, blade: 15 x 5 mm, pusher: 4 mm diameter Straight



**DE-2282**  
Blade and pusher Length 180 mm, for straight or angled, blade: 15 x 5 mm, pusher: 4 mm diameter angular



**DE-2283**  
Spoon and pusher Length 180 mm, for angled spoon: 10 x 5 mm, pusher: diameter 3 mm



**DE-2284**  
Graft Packer, Smooth Tips DE 5/8mm



**DE-2285**  
Graft Packer, Serrated Tips DE 3/4mm



**DE-2286**  
Graft Packer, Serrated Tips DE 6/8mm



**DE-2287**  
Titanium graft packer/placement site depth gauge 3.3mm & 4.0mm Diameter tips Marked at 8, 11, 13, 15 & 18mm



**DE-2288**  
Tamper Length 170 mm, for bone material, double-ended, diameter 3.2 mm (2-4-6-8-10) and diameter 2.5mm (2-4-6-8-10)



- Инструменты для имплантологии
  - Implantologie
  - Implantologie
- Инструменти для імплантології
  - Implantologia
  - زراعة الأسنان

## SPOON AND PUSHER (TRINOVO)

Trinovo handle, different workers, for bone material, high-grade medical stainless steel, corrosion-resistant



# IMPLANTOLOGY



- Инструменты для имплантологии
- Implantologie
- Implantologie

- Інструменти для імплантології
- Implantologia
- زراعة الأسنان

Hollow Handle 10mm Length 170mm



DE-2296 Miller



DE-2297 Miller



DE-2298 LUCAS #84



DE-2299 LUCAS #85



DE-2300 LUCAS #86



DE-2301 LUCAS #87



DE-2302 LUCAS #88



DE-2303 LUCAS86S  
SERRATED



DE-2304 LUCAS86AS  
SERRATED

- Инструменты для имплантологии
- Implantologie
- Implantologie
- Инструменти для імплантології
- Implantologia
- زراعة الأسنان

## TISSUE MEMBRANE FORCEPS



**DE-2305**  
Tissue Graft Forcep  
Serrated Teeth



**DE-2306**  
Self Locking  
Grooved



**DE-2307**  
Tissue Graft Forcep  
Serrated Teeth



**DE-2308**  
Titanium  
Locking Plier



**DE-2309**  
TC Gripper Carbide  
Tipped Tissue Forceps  
Serrated Carbide Tips  
14.5cm



**DE-2310**  
Adson Carbide  
Tipped Tissue Forceps  
Serrated Carbide Tips  
12cm



**DE-2311**  
Micor Adson 1x2  
Tissue Forcep 12.1cm  
1x2 Teeth - 0.5mm Tips



**DE-2312**  
Adson 7x7  
Tissue Forceps  
7x7 Teeth 12cm



**DE-2313**  
Adson 7x7 Curved  
Tissue Forceps  
7x7 Teeth 12cm



**DE-2314**  
Suture Pliers  
Suture Forceps with  
1.6mm Ring Tip



**DE-2315**  
DeBakey Atraumatic  
Tissue Forceps Straight  
Serrated Teeth  
16cm



**DE-2316**  
DeBakey Atraumatic  
Tissue Forceps Curved  
Serrated Teeth  
16cm



# IMPLANTOLOGY



- Инструменты для имплантологии
- Implantologie
- Implantologie
- Инструменти для імплантології
- Implantologia
- زراعة الأسنان

## TISSUE MEMBRANE FORCEPS



**DE-2317**  
Russian Long  
Tissue Forceps  
Serrated Tip  
20cm



**DE-2318**  
Russian  
Tissue Forceps  
Serrated Tip  
15cm



**DE-2319**  
Tissue Punch Forceps  
To Remove Tissue  
After Using Punch



**DE-2320**  
13.5 cm  
narrow



**DE-2321**  
10.5 cm  
**Membrane tweezers KUEHNE**



**DE-2322**  
13.5 cm  
wide



**DE-2323**  
**Pin-Tweezers**  
with or without lock,  
length 15 cm,  
with lock



**DE-2324**  
without lock



**DE-2325**  
**Haltepinzette with lock**  
15,5 cm, for pins, towards  
the tips, etc



**DE-2326**  
Carry Forceps  
15cm



1.3mm & 1.9mm  
**DE-2327**  
Carry Forceps  
15cm



3.0mm  
**DE-2328**  
Carry Forceps  
15cm

- Инструменты для имплантологии
- Implantologie
- Implantologie
- Инструменти для імплантології
- Implantologia
- زراعة الأسنان

## OSTEOTOME CONVEXES / CONCAVE / CONIQUES

CONVEXES

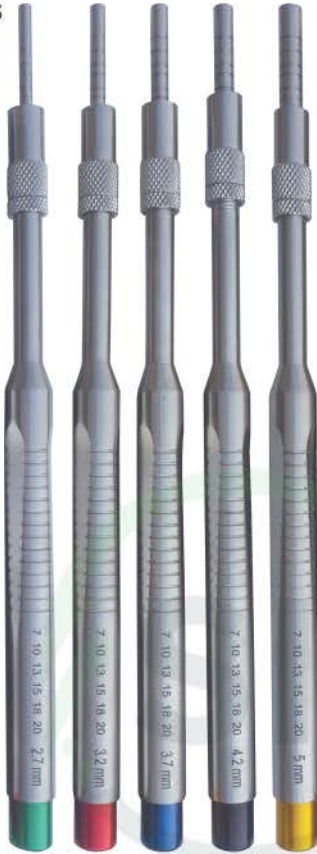

**DE-2329**  
SET OF 5 PIECES

CONCAVES

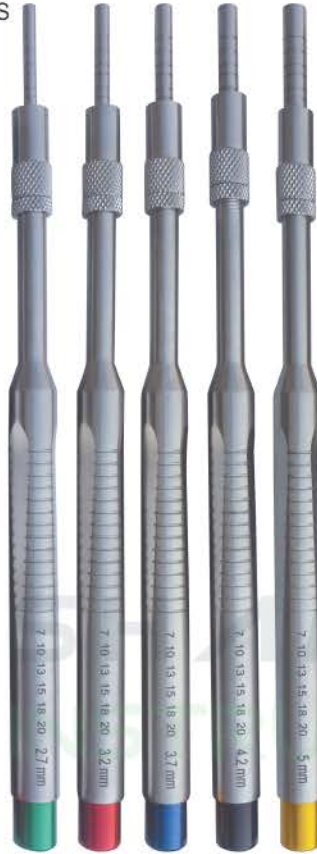

**DE-2330**  
SET OF 5 PIECES

CONIQUES

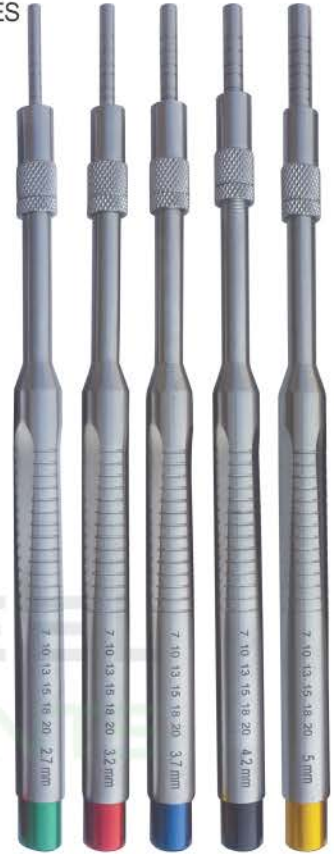

**DE-2331**  
SET OF 5 PIECES

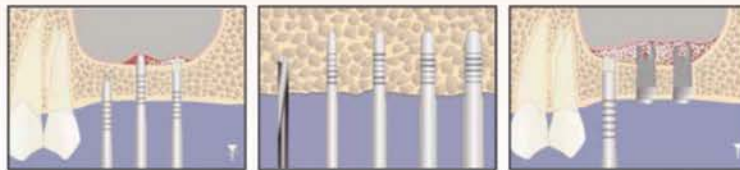

	CONVEXES STRAIGHT	DE-2329	2,7 Ømm	3,2 Ømm	3,7 Ømm	4,2 Ømm	5 Ømm
	CONCAVES STRAIGHT	DE-2330	2,7 Ømm	3,2 Ømm	3,7 Ømm	4,2 Ømm	5 Ømm
	CONIQUES STRAIGHT	DE-2331	2,7 Ømm	3,2 Ømm	3,7 Ømm	4,2 Ømm	5 Ømm

# IMPLANTOLOGY



- Инструменты для имплантологии
- Implantologie
- Implantologia
- زراعة الأسنان

## OSTEOTOME CONVEXES / CONCAVE / CONIQUES



**DE-2332**  
SET OF 5 PIECES

**DE-2333**  
SET OF 5 PIECES

**DE-2334**  
SET OF 5 PIECES

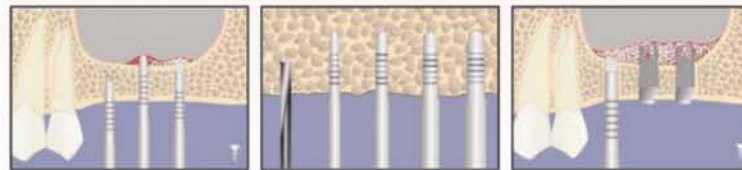

	CONVEXES CURVED	DE-2332	2,7 Ømm	3,2 Ømm	3,7 Ømm	4,2 Ømm	5 Ømm
	CONCAVES CURVED	DE-2333	2,7 Ømm	3,2 Ømm	3,7 Ømm	4,2 Ømm	5 Ømm
	CONIQUES CURVED	DE-2334	2,7 Ømm	3,2 Ømm	3,7 Ømm	4,2 Ømm	5 Ømm





# IMPLANTOLOGY

- Инструменты для имплантологии
- Implantologie
- Implantologie
- Инструменти для імплантології
- Implantologia
- زراعة الأسنان

## BONE SCRAPER STRAIGHT & CURVED



**DE-2335**  
Bone Scraper  
Straight

**DE-2336**  
Bone Scraper  
Curved

## TISSUE PUNCH STRAIGHT & CURVED



**Tissue Punch**  
Straight



**Tissue Punch**  
Curved

●  
**DE-2337**  
2.0mm

●  
**DE-2338**  
4.0mm

●  
**DE-2339**  
5.0mm

●  
**DE-2340**  
6.0mm

●  
**DE-2341**  
7.0mm

●  
**DE-2342**  
8.0mm

●  
**DE-2343**  
2.0mm

●  
**DE-2344**  
4.0mm

●  
**DE-2345**  
5.0mm

●  
**DE-2346**  
6.0mm

●  
**DE-2347**  
7.0mm

●  
**DE-2348**  
8.0mm

Ø4.0   Ø5.0   Ø6.0   Ø7.0



**DE-2349**  
Tissue Punch with pin  
Set of Four Pieces



**DE-2350**  
Tissue Punch  
Set of Five Pieces



**DE-2351**  
Tissue Punch  
Set of Five Pieces

# IMPLANTOLOGY



- Инструменты для имплантологии
- Implantologie
- Implantologie
- Инструменти для имплантології
- Implantologia
- زراعة الأسنان

## BONE MILL BONE WELL

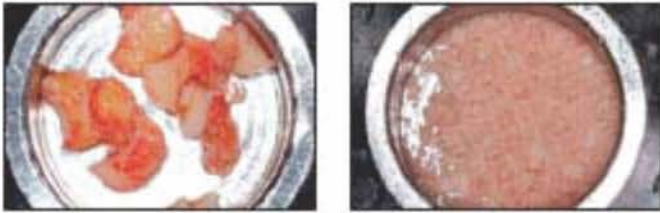

- Инструменты для имплантологии
- Implantologie
- Implantologie
- Инструменти для імплантології
- Implantologia
- زراعة الأسنان

## TREPHINE

Burs with depth markings are suited for precise and simple transplantation of cylindrical bone grafts as well as for all other bone-extraction tasks.



## BONE INJECTORS, COLLECTORS & SUCTION TUBE

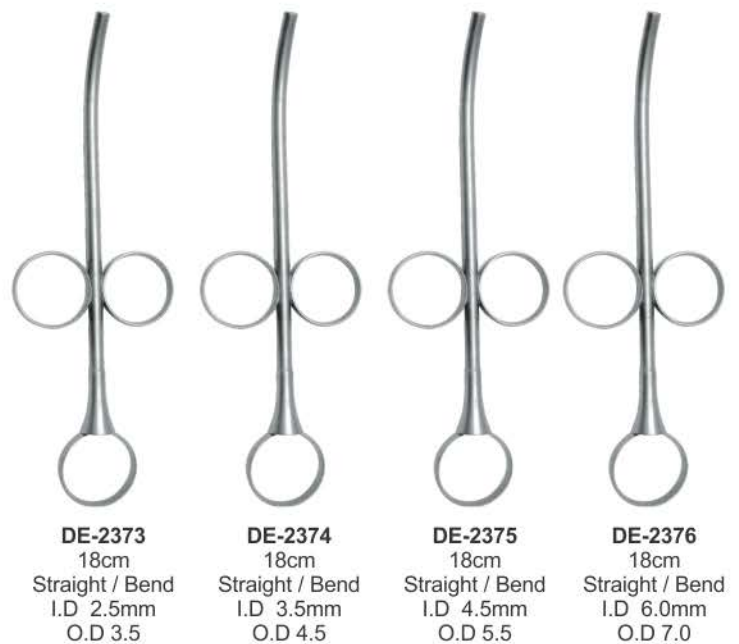
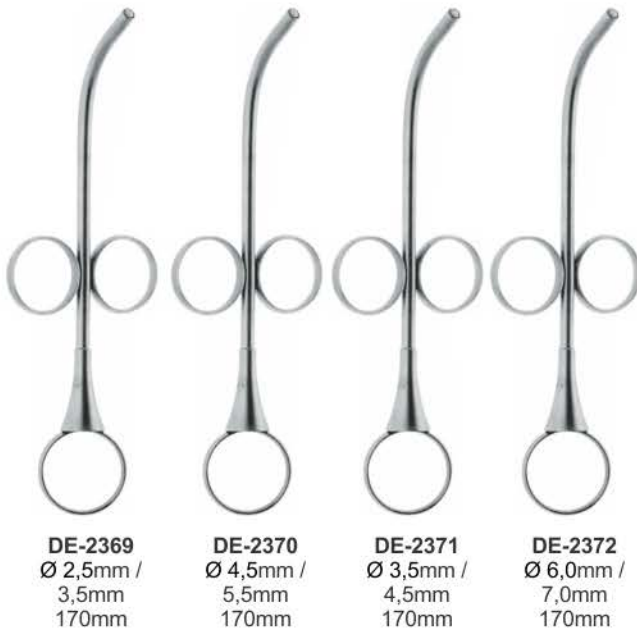



# IMPLANTOLOGY



- Инструменты для имплантологии
- Implantologie
- Implantologie
- Инструменти для имплантології
- Implantoloia
- زراعة الأسنان

## BONE EXPANDER SCREW & SURGICAL KITS



Ø2.0mm    Ø2.5mm    Ø2.8mm

**DE-2377** Short Implant Drills



Ø3.2mm    Ø3.65mm    Ø4.2mm    Ø5.2mm

**DE-2378** Long Implant Drills



**DE-2379**

Bone Universal Kit  
 Drill: 2mm, 2.8mm, 3.2mm, 3.65mm, 4.2mm, 4.5mm, 4.8mm, 5.2mm  
 Trephines Bit: 3.0mm, 4.0mm, 5.0mm, 6.0mm, 7.0mm, 8.0mm, 9.0mm, 10mm.  
 Driver: 2.5mm, 2.5mm Hand Pcs, 1.25mm, 1.25mm Hand Pcs  
 Short Driver 2.5mm, Long Driver 2.5mm  
 1.25mm, Short Hex Driver Hand Pcs  
 1.25mm, Long Hex Driver Hand Pcs, Torque Wrench 4.0mm

**DE-2380**

Bone Expander Kit  
 Expander: 2.6mm, 3.0mm, 3.4mm, 3.8mm, 4.3mm  
 Ratchet Driver, Parallel Pin  
 Pilot Drill, Drill 1.4mm, Drill Driver 4mm  
 Hand Driver 4mm, Ratchet 4.0mm



**DE-2381**

Bone Universal Kit  
 Drill: 2mm, 2.8mm, 3.2mm, 3.65mm, 4.2mm, 4.5mm, 4.8mm, 5.2mm  
 Trephines Bit:  
 3.0mm, 4.0mm, 5.0mm, 6.0mm, 7.0mm, 8.0mm, 9.0mm, 10mm.

Bone Compression:  
 2mm, 3.3mm, 2.8mm, 4.2mm, 3mm, 3.5mm  
 Driver:  
 2.5mm, 2.5mm Hand Pcs  
 1.25mm, 1.25mm Hand Pcs  
 Short Driver 2.5mm  
 Long Driver 2.5mm  
 1.25mm, Short Hex Driver Hand Pcs  
 1.25mm, Long Hex Driver Hand Pcs  
 Torque Wrench 6.35mm 1 Pcs

**DE-2382**

Conical Drills: 20 Pcs  
 Tissue Punches:  
 3.0mm, 3.50mm, 4.0mm, 4.5mm, 5.0mm, 6.0mm, 6.50mm  
 Bone Expander:  
 1.6/3.8mm, 1.9/3.0mm, 2.1/3.6mm, 2.6/3.8mm, 2.9/4.3mm  
 Drill Adapter: 1 Pcs  
 1.25mm, 2.50mm Hex Driver Hand Pcs

Pilot Drill: 1.6mm  
 Drill Bit: 1.4mm, 1.6mm, 1.8mm, 2.0mm, 2.2mm  
 Ratchet Driver: 4mm/6.35, 1.25/2.50  
 Rimer: 3.2/4.7mm, 3.7/4.7mm  
 Parallel Pin: 4.5mm, 2.5mm  
 Double step Drill: 2.4/2.8mm  
 Depth Gauge: 1 Pcs  
 Torque Wrench 6.35mm Universal: 1 Pcs

- Инструменты для имплантологии
  - Implantologie
  - Implantologie
- Инструменти для імплантології
  - Implantologia
  - زراعة الأسنان

## KEYS FOR IMPLANT SCREW



DE-2383



DE-2384



DE-2385



DE-2386

## TORQUE WRENCH & RATCHET



DE-2387 Star Torque Wrench 6.35mm Universal



DE-2388 Round Torque Wrench 4.0mm Universal



DE-2389 Hex Driver With 4.0mm Driver



DE-2390 Star Torque Wrench 6.35mm Universal



DE-2391 Hex Torque Wrench 4.00mm Universal



DE-2392 Star Torque Wrench 6.35mm Universal



DE-2393 Star Torque Wrench 6.35mm Universal



DE-2394 Star Torque Wrench 6.35mm Universal



DE-2395 Star Torque Wrench 6.35mm Universal



DE-2396 Star Torque Wrench 6.35mm Universal



DE-2397 Star Ratchet Wrench 6.35mm Universal



DE-2398 Star Ratchet Wrench 6.35mm Universal



DE-2399 Star Ratchet Wrench 6.35mm Universal



DE-2400 Star Ratchet Wrench 4.0mm Universal



DE-2401 Round Ratchet Wrench 4.0mm Universal



DE-2402 Round Ratchet Wrench 3.35mm Universal



DE-2403 Star Ratchet Wrench 4.0mm Universal



DE-2404 Star Ratchet Wrench 6.35mm Universal

# IMPLANTOLOGY



- Инструменты для имплантологии
- Implantologie
- Implantologie

- Инструменти для імплантології
- Implantologia
- زراعة الأسنان



**DE-2405**  
Suction Cannula Kit  
with 3 Needles



Suction Pipe



Suction Needle  
1mm



Suction Needle  
1.5mm



Suction Needle  
2mm



**DE-2406**  
17.5cm

**DE-2407**  
18cm

**DE-2408**  
coarse  
Ø 5mm

Suction tubes to collect  
the extracted  
bone material  
180mm



**DE-2409**  
fine  
Ø 9mm



**DE-2410**  
Suction  
Tubes  
180mm

**DE-2411**  
Suction  
Tubes  
180mm

**DE-2412**  
Suction  
Tubes  
180mm



**DE-2413**  
Fig. 6FR  
Frazier  
15 cm - Ø 2 mm

**DE-2414**  
Ø 3 mm  
length 180mm  
**DE-2415**  
Ø 4 mm  
length 180mm  
**DE-2416**  
Ø 5 mm  
length 180mm





## IMPRESSION TRAYS

- Оттисные ложки
- Porte-empreinte
- Abdrucklöffel
- Відбиткові ложки
- Cubetas para impresiones
- صواني الانطباع

### PERFORATED WITH RIM LOCK

Set of 06 Pcs



#### DE-2417 SET OF 06 PCS

Upper: S, M, L  
Lower: S, M, L

### PERFORATED WITH RIM LOCK

Set of 8 Pcs

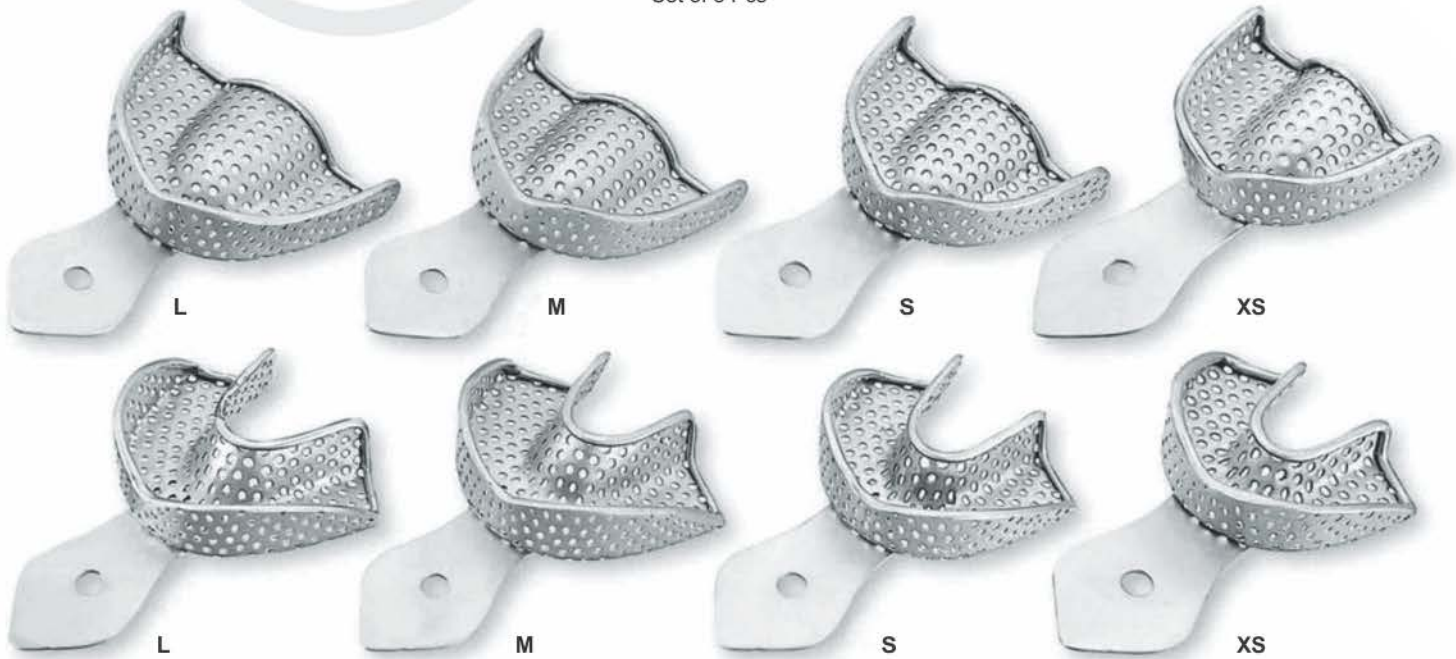

#### DE-2418 SET OF 08 PCS

Upper: XS, S, M, L  
Lower: XS, S, M, L

#### DE-2419 SET OF 08 PCS

Upper: S, M, L, XL  
Lower: S, M, L, XL

#### DE-2420 SET OF 10 PCS

Upper: XS, S, M, L, XL  
Lower: XS, S, M, L, XL

# IMPRESSION TRAYS



- Оттисковые ложки
- Porte-empreinte
- Abdrucklöffel

- Відбиткові ложки
- Cubetas para impresiones
- صواني الانطباع

## SOLID WITH RIM LOCK

Set of 6 Pcs



### DE-2421 SET OF 06 PCS

Upper: S, M, L  
Lower: S, M, L

## SOLID WITH RIM LOCK

Set of 8 Pcs



### DE-2422 SET OF 08 PCS

Upper: XS, S, M, L  
Lower: XS, S, M, L

### DE-2423 SET OF 08 PCS

Upper: S, M, L, XL  
Lower: S, M, L, XL

### DE-2424 SET OF 10 PCS

Upper: XS, S, M, L, XL  
Lower: XS, S, M, L, XL





## IMPRESSION TRAYS

- Оттисные ложки
- Porte-empreinte
- Abdrucklöffel
- Відбиткові ложки
- Cubetas para impresiones
- صوتاني الانطباع

### PERFORATED FULL DENTURE

Set of 8 Pcs

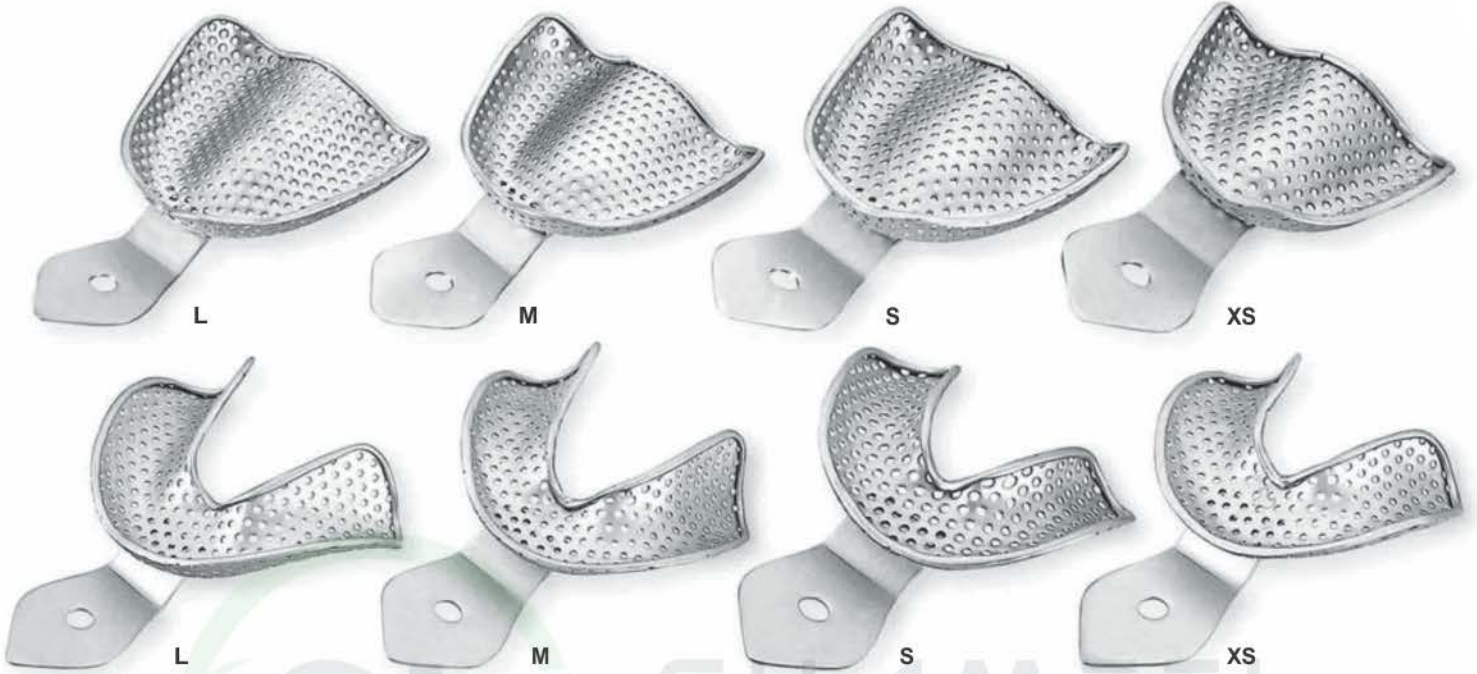

**DE-2425 SET OF 08 PCS**  
Upper: S, M, L, XL  
Lower: S, M, L, XL

**DE-2426 SET OF 08 PCS**  
Upper: S, M, L  
Lower: S, M, L

### SOLID FULL DENTURE

Set of 8 Pcs

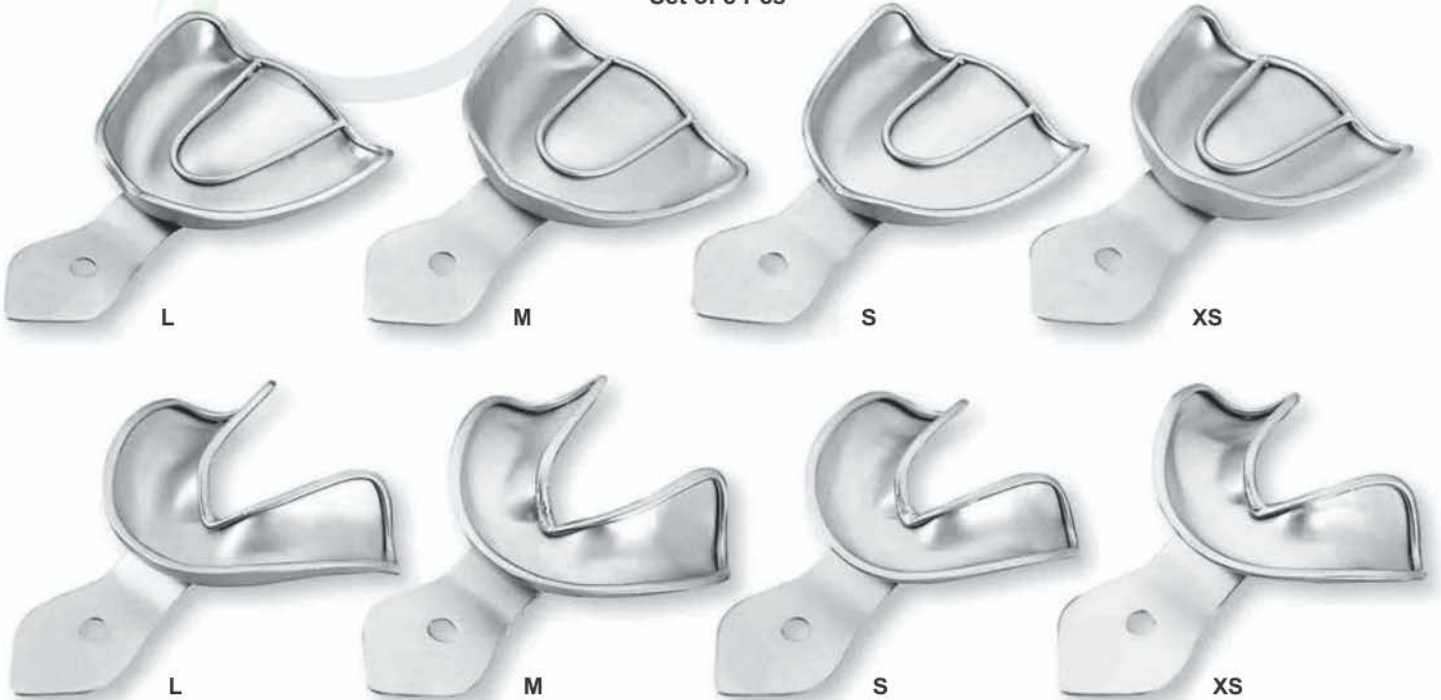

**DE-2427 SET OF 08 PCS**  
Upper: S, M, L, XL  
Lower: S, M, L, XL

**DE-2428 SET OF 06 PCS**  
Upper: S, M, L  
Lower: S, M, L



# IMPRESSION TRAYS



- Оттисные ложки
- Porte-empreinte
- Abdrucklöffel
- Відбиткові ложки
- Cubetas para impresiones
- صواني الانطباع

## Perforated Without Rim Lock



## Solid With Rim Lock

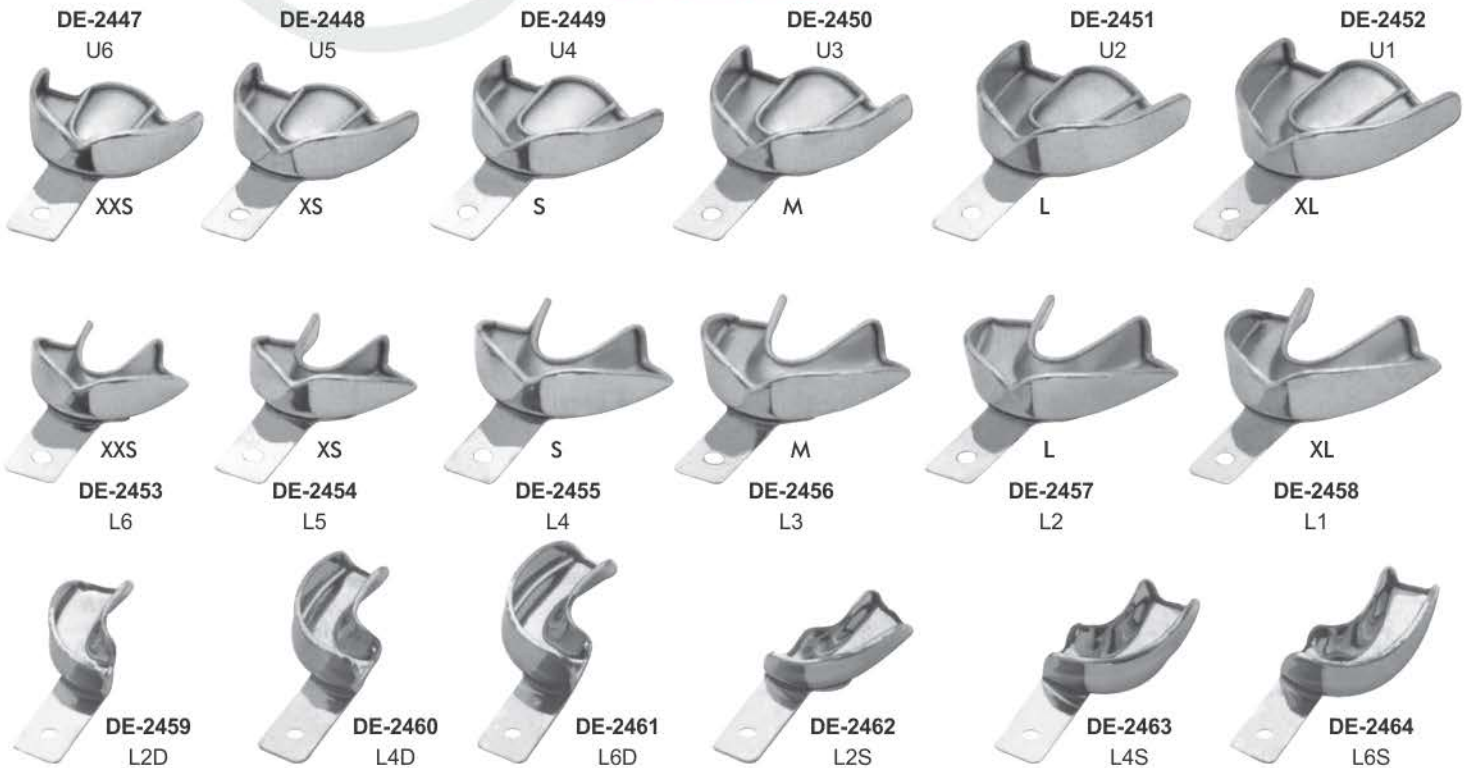



# HOLLOWARE INSTRUMENTS





**Scalers Tray**  
DE-2500 200 x 100 mm



**Scalers Trays**  
DE-2501 205 x 115 x 17 mm  
DE-2502 205 x 152 x 17 mm  
DE-2503 290 x 115 x 17 mm



**Instruments Trays**  
DE-2504 200 x 110 x 30 mm  
DE-2505 215 x 115 x 35 mm  
DE-2506 220 x 130 x 30 mm  
DE-2507 230 x 125 x 35 mm  
DE-2508 245 x 140 x 40 mm  
DE-2509 285 x 160 x 45 mm  
DE-2510 315 x 175 x 50 mm  
DE-2511 330 x 185 x 50 mm



**Instruments Trays**  
DE-2512 150 x 100 x 50 mm  
DE-2513 200 x 100 x 50 mm  
DE-2514 220 x 120 x 50 mm  
DE-2515 240 x 140 x 50 mm  
DE-2516 200 x 150 x 50 mm  
DE-2517 250 x 200 x 50 mm  
DE-2518 300 x 250 x 50 mm  
DE-2519 300 x 200 x 50 mm  
DE-2520 350 x 250 x 50 mm  
DE-2521 400 x 300 x 50 mm  
DE-2522 450 x 300 x 50 mm  
DE-2523 450 x 350 x 50 mm



**Instruments Trays With Lid**  
DE-2524 150 x 100 x 50 mm  
DE-2525 200 x 100 x 50 mm  
DE-2526 220 x 120 x 50 mm  
DE-2527 240 x 140 x 50 mm  
DE-2528 200 x 150 x 50 mm  
DE-2529 250 x 200 x 50 mm  
DE-2530 300 x 250 x 50 mm  
DE-2531 300 x 200 x 50 mm  
DE-2532 350 x 250 x 50 mm  
DE-2533 400 x 300 x 50 mm  
DE-2534 450 x 300 x 50 mm  
DE-2535 450 x 350 x 50 mm



**Mayo Tray Perforated**  
DE-2536 150 x 100 x 25 mm  
DE-2537 200 x 100 x 25 mm  
DE-2538 220 x 120 x 25 mm  
DE-2539 240 x 140 x 25 mm  
DE-2540 200 x 150 x 25 mm  
DE-2541 250 x 200 x 25 mm  
DE-2542 300 x 250 x 25 mm  
DE-2543 300 x 200 x 25 mm  
DE-2544 350 x 250 x 25 mm  
DE-2545 400 x 300 x 25 mm  
DE-2546 450 x 300 x 25 mm  
DE-2547 450 x 350 x 25 mm



**Scaler Tray**  
DE-2548 200 x 115 mm  
DE-2549 205 x 150 mm  
DE-2550 290 x 150 mm  
DE-2551 300 x 200 mm



**Instruments Tray Perforated**  
DE-2552 150 x 100 x 50 mm  
DE-2553 200 x 100 x 50 mm  
DE-2554 220 x 120 x 50 mm  
DE-2555 240 x 140 x 50 mm  
DE-2556 200 x 150 x 50 mm  
DE-2557 250 x 200 x 50 mm  
DE-2558 300 x 250 x 50 mm  
DE-2559 300 x 200 x 50 mm  
DE-2560 350 x 250 x 50 mm  
DE-2561 400 x 300 x 50 mm  
DE-2562 450 x 300 x 50 mm  
DE-2563 450 x 350 x 50 mm





# HOLLOWARE INSTRUMENTS

## Sterilizing boxes & instruments Trays



- Instruments Box with Hooks**  
 DE-2564 170 x 70 x 30 mm  
 DE-2565 180 x 80 x 40 mm  
 DE-2566 200 x 100 x 40 mm  
 DE-2567 200 x 100 x 50 mm  
 DE-2568 220 x 120 x 50 mm  
 DE-2569 250 x 150 x 50 mm  
 DE-2570 250 x 200 x 50 mm  
 DE-2571 300 x 150 x 60 mm  
 DE-2572 300 x 200 x 50 mm  
 DE-2573 350 x 250 x 50 mm  
 DE-2574 400 x 200 x 100 mm  
 DE-2575 450 x 250 x 50 mm



- Instruments Box**  
 DE-2576 170 x 70 x 30 mm  
 DE-2577 180 x 80 x 40 mm  
 DE-2578 200 x 100 x 40 mm  
 DE-2579 200 x 100 x 50 mm  
 DE-2580 220 x 120 x 50 mm  
 DE-2581 250 x 150 x 50 mm  
 DE-2582 250 x 200 x 50 mm  
 DE-2583 300 x 150 x 60 mm  
 DE-2584 300 x 200 x 50 mm  
 DE-2585 350 x 250 x 50 mm  
 DE-2586 400 x 200 x 100 mm  
 DE-2587 450 x 250 x 50 mm



- Instruments Box Perforated**  
 DE-2588 170 x 70 x 30 mm  
 DE-2589 180 x 80 x 40 mm  
 DE-2590 200 x 100 x 40 mm  
 DE-2591 200 x 100 x 50 mm  
 DE-2592 220 x 120 x 50 mm  
 DE-2593 250 x 150 x 50 mm  
 DE-2594 250 x 200 x 50 mm  
 DE-2595 300 x 150 x 60 mm  
 DE-2596 300 x 200 x 50 mm  
 DE-2597 350 x 250 x 50 mm  
 DE-2598 400 x 200 x 100 mm  
 DE-2599 450 x 250 x 50 mm



**Gloves Box**  
 DE-2600 300 x 150 mm



- Catheters Tray with lid**  
 DE-2601 200 x 60 x 40 mm  
 DE-2602 200 x 90 x 40 mm  
 DE-2603 320 x 95 x 50 mm  
 DE-2604 328 x 90 x 50 mm  
 DE-2605 365 x 90 x 50 mm  
 DE-2606 440 x 115 x 50 mm



- Box With Filter**  
 DE-2607 100 x 50 mm  
 DE-2608 250 x 150 mm  
 DE-2609 150 x 65 mm  
 DE-2610 200 x 100 mm  
 DE-2611 300 x 200 mm



- Instruments Trays With Cover**  
 DE-2612 210 x 110 x 50 mm  
 DE-2613 240 x 160 x 50 mm  
 DE-2614 300 x 180 x 50 mm  
 DE-2615 360 x 210 x 50 mm  
 DE-2616 400 x 230 x 55 mm

- Instruments Trays Without Cover**  
 DE-2617 210 x 110 x 50 mm  
 DE-2618 240 x 160 x 50 mm  
 DE-2619 300 x 180 x 50 mm  
 DE-2620 360 x 210 x 50 mm  
 DE-2621 400 x 230 x 55 mm



- Instruments Box with lid**  
 DE-2622 170 x 70 x 30 mm  
 DE-2623 180 x 80 x 40 mm  
 DE-2624 200 x 100 x 40 mm  
 DE-2625 200 x 100 x 50 mm  
 DE-2626 220 x 120 x 50 mm  
 DE-2627 250 x 150 x 50 mm  
 DE-2628 250 x 200 x 50 mm  
 DE-2629 300 x 150 x 60 mm  
 DE-2630 300 x 200 x 50 mm  
 DE-2631 350 x 250 x 50 mm  
 DE-2632 400 x 200 x 100 mm  
 DE-2633 450 x 250 x 50 mm



**Kidney Tray**  
 DE-2634 160 mm  
 DE-2635 200 mm  
 DE-2636 250 mm  
 DE-2637 280 mm  
 DE-2638 300 mm



**Kidney Tray Shallow**  
 DE-2639 170 mm  
 DE-2640 220 mm  
 DE-2641 240 mm



**Kidney Tray With Cover**  
 DE-2642 160 mm  
 DE-2643 200 mm  
 DE-2644 250 mm  
 DE-2645 280 mm  
 DE-2646 300 mm



**Kidney Tray**  
 DE-2647 160 mm  
 DE-2648 200 mm  
 DE-2649 250 mm  
 DE-2650 280 mm  
 DE-2651 300 mm



**Forceps Jars**  
 DE-2652 30 x 90 mm  
 DE-2653 50 x 100 mm  
 DE-2654 50 x 130 mm  
 DE-2655 50 x 175 mm  
 DE-2656 75 x 100 mm  
 DE-2657 75 x 130 mm  
 DE-2658 75 x 175 mm  
 DE-2659 100 x 175 mm  
 DE-2660 100 x 200 mm



**Methot Jar Without Lid**  
 DE-2661



**Dressing Jar / Cotton Container**  
 DE-2662 80 x 80 mm  
 DE-2663 100 x 60 mm  
 DE-2664 100 x 80 mm  
 DE-2665 100 x 100 mm  
 DE-2666 120 x 80 mm  
 DE-2667 120 x 100 mm  
 DE-2668 150 x 100 mm  
 DE-2669 150 x 150 mm  
 DE-2670 180 x 150 mm  
 DE-2671 180 x 180 mm  
 DE-2672 200 x 200 mm  
 DE-2673 240 x 240 mm



**Sputum Cup**  
 DE-2674



**Dressing Jar With Lid & Knob**  
 DE-2675 80 x 80 mm  
 DE-2676 90 x 90 mm  
 DE-2677 100 x 100 mm  
 DE-2678 120 x 120 mm  
 DE-2679 100 x 130 mm  
 DE-2680 150 x 150 mm  
 DE-2681 125 x 170 mm



**Round Bowls**  
 DE-2682 80 x 35 mm  
 DE-2683 125 x 60 mm



## HOLLOWARE INSTRUMENTS



Spirit Lamp  
DE-2684



Spirit Lamp  
DE-2685



Spirit Lamp  
DE-2686



Cotton Holding Jar  
DE-2687



Cotton Holder  
DE-2688



Cotton Holder  
DE-2689



Cotton Wool Dispenser Acc.  
to Methot  
DE-2690



Needle Sterilization Tub  
DE-2691



Round Endodontic Boxes  
complete with lid  
DE-2692 Ø mm. 94 - h. mm. 70



Endodontic Box  
DE-2693





**DE-2694**  
100 x 180 x 11mm  
Mini size



**DE-2695**  
100 x 180 x 11mm  
Mini size



**DE-2696**  
100 x 180 x 11mm  
Mini size



**DE-2697**  
100 x 180 x 11mm  
Mini size



**DE-2698**  
100 x 180 x 11mm  
Mini size



Lid  
Coperchio

**DE-2699**  
103 x 182 x 10mm  
Mini size



**DE-2700**  
Silver



**DE-2701** Blue  
**DE-2702** Red



**DE-2703** Blue  
**DE-2704** Red



**DE-2705**  
Silver



**DE-2706**  
Green



**DE-2708**  
Blue



**DE-2707**  
Golden



**DE-2709**  
Red



**DE-2710**  
Silver



**DE-2711**  
Midi  
125 x 105 x 54mm



**DE-2712**  
Maxi  
204 x 105 x 54mm

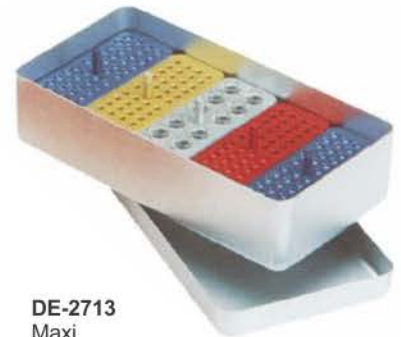

**DE-2713**  
Maxi  
204 x 105 x 54mm



### Round Sterilizer Drum

DE-2714	mm. Ø 80 x 80 H
DE-2715	mm. Ø 125 x 80 H
DE-2716	mm. Ø 125 x 100 H
DE-2717	mm. Ø 125 x 125 H
DE-2718	mm. Ø 150 x 80 H
DE-2719	mm. Ø 150 x 100 H
DE-2720	mm. Ø 150 x 130 H
DE-2721	mm. Ø 150 x 150 H
DE-2722	mm. Ø 150 x 190 H
DE-2723	mm. Ø 190 x 125 H
DE-2724	mm. Ø 190 x 145 H
DE-2725	mm. Ø 190 x 165 H
DE-2726	mm. Ø 190 x 190 H
DE-2727	mm. Ø 190 x 240 H
DE-2728	mm. Ø 190 x 290 H
DE-2729	mm. Ø 240 x 120 H
DE-2730	mm. Ø 240 x 145 H
DE-2731	mm. Ø 240 x 165 H
DE-2732	mm. Ø 240 x 190 H
DE-2733	mm. Ø 240 x 240 H
DE-2734	mm. Ø 240 x 290 H
DE-2735	mm. Ø 240 x 340 H
DE-2736	mm. Ø 240 x 390 H
DE-2737	mm. Ø 290 x 145 H
DE-2738	mm. Ø 290 x 165 H
DE-2739	mm. Ø 290 x 190 H
DE-2740	mm. Ø 290 x 240 H
DE-2741	mm. Ø 290 x 290 H
DE-2742	mm. Ø 290 x 340 H
DE-2743	mm. Ø 290 x 390 H
DE-2744	mm. Ø 340 x 145 H
DE-2745	mm. Ø 340 x 165 H
DE-2746	mm. Ø 340 x 190 H
DE-2747	mm. Ø 340 x 240 H
DE-2748	mm. Ø 340 x 290 H
DE-2749	mm. Ø 340 x 340 H
DE-2750	mm. Ø 340 x 390 H
DE-2751	mm. Ø 390 x 140 H
DE-2752	mm. Ø 390 x 165 H
DE-2753	mm. Ø 390 x 190 H
DE-2754	mm. Ø 390 x 240 H
DE-2755	mm. Ø 390 x 290 H
DE-2756	mm. Ø 390 x 340 H
DE-2757	mm. Ø 390 x 390 H
DE-2758	mm. Ø 390 x 490 H

### Round Sterilizer Drums "Filter"

DE-2759	mm. Ø 80 x 80 H
DE-2760	mm. Ø 125 x 80 H
DE-2761	mm. Ø 125 x 100 H
DE-2762	mm. Ø 125 x 125 H
DE-2763	mm. Ø 150 x 100 H
DE-2764	mm. Ø 150 x 130 H
DE-2765	mm. Ø 150 x 150 H
DE-2766	mm. Ø 150 x 190 H
DE-2767	mm. Ø 190 x 145 H
DE-2768	mm. Ø 190 x 165 H
DE-2769	mm. Ø 190 x 190 H
DE-2770	mm. Ø 190 x 240 H
DE-2771	mm. Ø 240 x 145 H
DE-2772	mm. Ø 240 x 165 H
DE-2773	mm. Ø 240 x 190 H
DE-2774	mm. Ø 240 x 240 H
DE-2775	mm. Ø 240 x 290 H
DE-2776	mm. Ø 240 x 340 H
DE-2777	mm. Ø 240 x 390 H
DE-2778	mm. Ø 290 x 145 H
DE-2779	mm. Ø 290 x 165 H
DE-2780	mm. Ø 290 x 190 H
DE-2781	mm. Ø 290 x 240 H
DE-2782	mm. Ø 290 x 290 H
DE-2783	mm. Ø 290 x 340 H
DE-2784	mm. Ø 290 x 390 H
DE-2785	mm. Ø 340 x 145 H
DE-2786	mm. Ø 340 x 165 H
DE-2787	mm. Ø 340 x 190 H
DE-2788	mm. Ø 340 x 240 H
DE-2789	mm. Ø 340 x 290 H
DE-2790	mm. Ø 390 x 140 H
DE-2791	mm. Ø 390 x 165 H
DE-2792	mm. Ø 390 x 190 H
DE-2793	mm. Ø 390 x 240 H
DE-2794	mm. Ø 390 x 290 H
DE-2795	mm. Ø 390 x 340 H
DE-2796	mm. Ø 390 x 490 H

### Round Bowls With Cover

DE-2797	Ø 40 mm ml.30
DE-2798	Ø 60 mm ml.50
DE-2799	Ø 80 mm ml.150
DE-2800	Ø 100 mm ml.250
DE-2801	Ø 120 mm ml.450
DE-2802	Ø 150 mm ml.750
DE-2803	Ø 180 mm ml.1500
DE-2804	Ø 200 mm ml.2100
DE-2805	Ø 250 mm ml.3500

### Round Bowls With Out Cover

DE-2806	Ø 40 mm ml.30
DE-2807	Ø 60 mm ml.50
DE-2808	Ø 80 mm ml.150
DE-2809	Ø 100 mm ml.250
DE-2810	Ø 120 mm ml.450
DE-2811	Ø 150 mm ml.750
DE-2812	Ø 180 mm ml.1500
DE-2813	Ø 200 mm ml.2100
DE-2814	Ø 250 mm ml.3500



## INSTRUMENTS MANAGEMENT SYSTEM

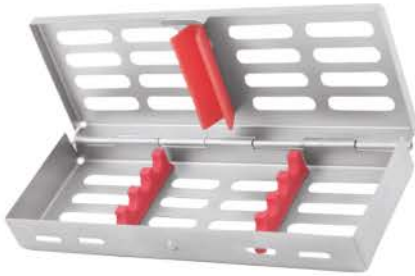

Cassette For 4 Instruments  
DE-2815



Cassette For 5 Instruments  
DE-2816



Cassette For 6 Instruments  
DE-2817



Cassette For 7 Instruments  
DE-2818



Cassette For 10 Instruments  
DE-2819



Cassette For 20 Instruments  
DE-2820



Cassette For Extraction Forceps  
DE-2821



Cassette For Root Elevator  
DE-2822



DE-2823  
Cassette Tray  
15 Pcs



DE-2824  
Cassette Tray  
15 Pcs





# HOLLOWARE INSTRUMENTS

## STERILIZING MESH TRAY

Different sizes & dimensions are available at buyer's demand



**MESH TRAYS**  
DE-2825  
Different sizes & dimensions are available at buyer's demand

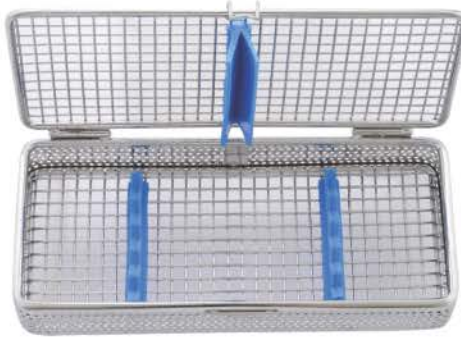

**MESH TRAYS**  
DE-2826  
05 Pcs



**MESH TRAYS**  
DE-2827  
07 Pcs



**MESH TRAYS**  
DE-2828  
10 Pcs



**MESH TRAYS**  
DE-2829  
20 Pcs



**DE-2830**  
Mesh Cassettes  
5 Pieces, 7 Pieces, 10 Pieces, 15 Pieces & 20 Pieces



**MESH TRAY**  
DE-2831 240x130x50mm  
DE-2832 240x130x60mm  
DE-2833 240x250x50mm  
DE-2834 240x250x60mm  
DE-2835 480x250x50mm  
DE-2836 480x250x60mm  
DE-2837 480x250x70mm



**MESH TRAY**  
DE-2838 240x250x 50mm  
DE-2839 240x250x 60mm  
DE-2840 240x250x 70mm  
DE-2841 480x250x 50mm  
DE-2842 480x250x 60mm  
DE-2843 480x250x 70mm  
DE-2844 480x250x100mm



**MESH TRAY**  
DE-2845 240x250x50mm  
DE-2846 240x250x60mm  
DE-2847 240x250x70mm  
DE-2848 280x250x50mm  
DE-2849 280x250x60mm



**MESH TRAY**  
DE-2850 280x250x 70mm  
DE-2851 280x250x100mm  
DE-2852 280x250x 50mm  
DE-2853 280x280x 60mm  
DE-2854 280x280x 70mm  
DE-2855 300x280x 60mm



**DE-2856**  
18×7×3.5cm  
5 Instruments Cassette  
Detachable Lids  
+  
5 Instruments Cassette Hinged  
Lids with button Lock



**DE-2857**  
29×18.5×3.5cm  
20 Instruments Cassette Hinged  
Lids with surgical kit fitting,  
button lock



**Instruments Cassette**  
**DE-2858** 5 Pieces Cassette  
**DE-2859** 7 Pieces Cassette  
**DE-2860** 10 Pieces Cassette



**DE-2861**  
18×11×3.5cm  
Extra large cassette for 6  
Instruments, with compartment  
for small parts hinged lids



**DE-2862**  
29×18.5×3.5cm  
20 Instruments Cassette  
Detachable Lids  
+  
20 Instruments Cassette Hinged  
Lids with button Lock



**DE-2863**  
10×13×2.2cm  
10 Instruments Cassette Hinged  
Lids, Click Lock Available in 2  
designs



**DE-2864**  
29×18.5×3.5cm  
20 Instruments Cassette Detachable  
Lids with elevator fitting  
+  
20 Instruments Cassette Hinged  
Lids with elevator fitting , button lock



**DE-2865**  
18×9×2.2cm  
7 Instruments Cassette Hinged  
Lids, Click Lock, Available in 2  
designs



**DE-2866**  
21×14×3.5cm  
15 Instruments cassette,  
Detachable lids, button lock



**DE-2867**  
21×14×3.5cm  
15 Instruments cassette,  
detachable lids, button  
lock, with fitting of micro  
surgery kit



**DE-2868**  
21x14x4.5cm  
8 pcs luxator/elevator  
cassette, Detach0  
ablelids, button lock



**DE-2869**  
15x9x5cm  
Box for dental implant tools and  
surgical kits, Capacity:8  
tools, 18 tools, 24 Tools, 58 Tools  
+ removable compartment



**Instruments Tray Perforated**  
**DE-2870** 288 x 187 x 40 mm



**Instruments Tray Perforated Base**  
**DE-2871** 288 x 187 x 40 mm



**Instruments Tray Solid Base**  
**DE-2872** 288 x 187 x 40 mm





**DE-2873** Implant Basic Starter Kit 11 instruments with case



**DE-2874** Crown Bridge Set Instruments with Case



**DE-2875** Bone Curettes Spoon Style set of 4 with Metal Case

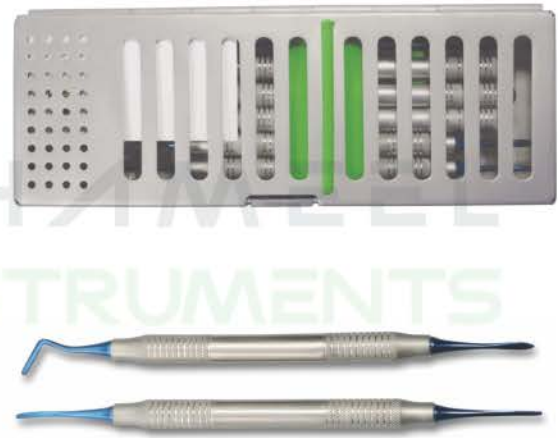

**DE-2876** Peritome Set of 2 with Blue Nitrate Tips and Metal Case

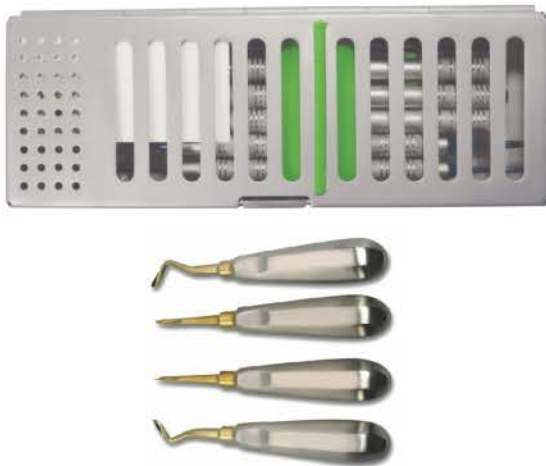

**DE-2877** Root Fragment Removal elevators, Set of 4 with Metal Case

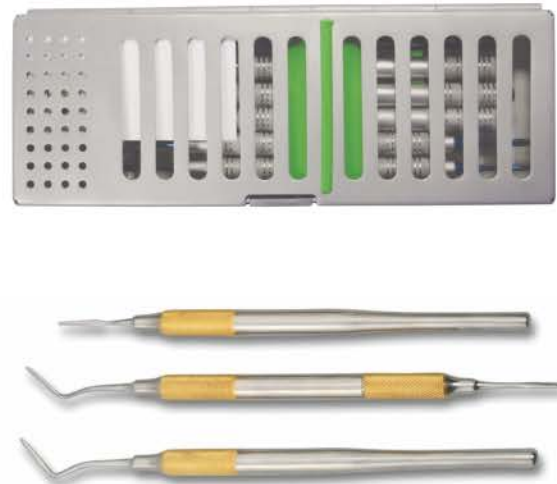

**DE-2878** Peritome Set of 3 Gold Handles Serrated Blades with Metal Case





DESCRIPTION PAGE#

**A**

A COSMETIC CONTOURING IMPLANTOLOGY ..... 148

AB1 BOGHOSIAN IMPLANTOLOGY ..... 147

AB2 BOGHOSIAN IMPLANTOLOGY ..... 147

ABDU-RASS EXPLORERS ..... 54

ACUTE IMPLANTOLOGY ..... 161

ADAMS PLIER ..... 133

ADAMS PLIER ROUND BOX ..... 133

ADAMS PLIERS FOR HOOKS AND BENDING ..... 138

ADAMS, SMALL WIRE BENDING AND LOOP FORMING PLIERS ..... 132

ADERER CLAMP THREE JAW WIRE BENDING PLIER ..... 138

ADERER FACEBOW LOOP FORMING PLIERS ..... 134

ADERER LARGE WIRE BENDING AND LOOP FORMING PLIERS ..... 133

ADERER PLIER ..... 134

ADHESIVE REMOVING PLIERS ..... 36,141

ADSON 7X7 CURVED TISSUE FORCEPS ..... 169

ADSON BROWN TWEEZERS ..... 53

ADSON CARBIDE TIPPED TISSUE FORCEPS ..... 169

ADSON NEEDLE HOLDERS ..... 107

ADSON-TC TWEEZERS ..... 53

ADULT PALATAL DENTAL PHOTOGRAPHIC MIRRORS ..... 98

ALLIS HAEMOSTATIC FORCEPS ..... 110

ALLIS-BABY HAEMOSTATIC FORCEPS ..... 110

ALL-PURPOSE PLIERS ..... 109

ALUMINIUM CALIPER ..... 127

ALUM RETRACTOR ..... 102

AMALGAM CARRIERS ..... 117

AMALGAM INSTRUMENTS ..... 116,117

AMALGAM WELL ..... 115,117

ANATOMIC HANDLE EXPLORERS ..... 54

ANDREWS FILLING INSTRUMENTS ..... 87

ANGLE HOW PLIER ..... 139

ANGLED DIRECT BOND BRACKET REMOVER TC ..... 139

ANGLED EXTRACTING FORCEPS FOR UPPER ROOTS ..... 03

ANGLED UTILITY PLIERS ..... 136

ANISWORTH RUBBER DAM CLAMPS FORCEPS ..... 111

ANTERIOR ..... 58

APEX FORCEPS LOWER ROOT DEEP ROOT PICK ..... 06

APEX FORCEPS LOWER UNIVERSAL DEEP ROOT PICK ..... 05

APEXO ROOT ELEVATORS ..... 29

APICAL RETENTION FORCEPS ..... 31,33

ARCH BENDING PLIERS ..... 38,143

ARROW CLASP FORMING PLIERS ..... 139

ARTICULATORS ..... 87

ASPIRATING SYRING ..... 27

ATRAUMATIC TWEEZERS ..... 52

ATRAUMATIC WITH LOCK TWEEZERS ..... 52

**B**

BABY TOOTH EXTRACTION FORCEPS SET OF 7 PIECES ..... 08

BACK ACTION FILLING INSTRUMENTS ..... 88

BACKHAUS HAEMOSTATIC FORCEPS ..... 110

BACKHAUS TOWEL CLAMPS ..... 110

BACOLITE HANDLE WAX KNIVES ..... 96

BALL BURNISHERS ..... 71

BALL FILLING INSTRUMENTS ..... 93

BALL SOCKET NOT-PERFORATING AND NOT-DAMAGING ..... 110

BALLACORN FILLING INSTRUMENTS ..... 88

BAND REMOVING PLIERS ..... 32,136

BAND SEATER AUTO CLEAVABLE ..... 129

BAND SEATER AUTO CLEAVABLE ROUND SHAPE ..... 129

BAND SEATER AUTO CLEAVABLE SQUARE SHAPE ..... 129

BAND SEATER AUTO CLEAVABLE TRIANGLE SHAPE ..... 129

BAND SEATING & REMOVING INSTRUMENTS ..... 129

BAND SEATING & REMOVING SILICON GRIP ..... 129

BAND SEATING PLIERS ..... 141

BANDS & CROWNS PLIER ..... 134

BARRAQUER T.C NEEDLE HOLDERS ..... 109

BASINS FOR BONE ..... 174

BAUMGARTNER NEEDLE HOLDERS ..... 06,107

BAYONET ROOTS ELEVATOR SET ..... 36

BEAVERTAIL FILLING INSTRUMENTS ..... 88

BEEBEE GUM SCISSORS ..... 106

BEERENDONK CALIPER ..... 127

BEIN ROOT ELEVATORS ..... 29,40

BENDING PLIER ..... 138

BESEK COMPOSITE INSTRUMENTS ..... 72

BESEK COMPOSITE MODELLING INSTRUMENTS ..... 85

BESEK COMPOSITE PLUGGERS INSTRUMENTS ..... 82

BESEK PLUGGERS ..... 76

BEYER BONE ROUNDER ..... 25

BINANGLE SCALER ..... 67

BIRD BEAK PLIER ..... 38,141

BIRD BEAK PLIER FOR BENDING ..... 138

BIRD BEAK PLIER STANDARD ..... 133

BIRD BEAK WIRE BENDING & CUTTING PLIERS ..... 134

BIRD BEAK WIRE BENDING PLIER ..... 133

BISHOP RETRACTORS ..... 101

BLACK FILLING INSTRUMENTS ..... 80,87

BLACK SCALER ..... 66

BLACK TITANIUM COLOUR COATED INSTRUMENTS ..... 147,148,149

BLADE AND PUSHER ..... 166

BLUE TITANIUM COATED BONE GRAFTING INSTRUMENTS ..... 59,187

SET OF 7 PCS WITH CASSETTE ..... 159

BLUMENTHAL BONE ROUNDER ..... 25

BOLEY GAUGE ..... 127

BONE BRACKET GAUGE ..... 125

BONE CARRIER TITANIUM ..... 165

BONE CRUSHER ..... 174

BONE CRUSHER TITANIUM METAL CUTTER ..... 174

BONE EXPANDER KIT ..... 176

BONE EXPANDER SCREW & SURGICAL KITS ..... 176

BONE FILES ..... 119

BONE GRAFT ..... 159

BONE GRAFT IMPLANTOLOGY ..... 156

BONE GRAFT PACKER ..... 164

BONE GRAFT/CARRIER TITANIUM ..... 167

BONE GRAFTING INSTRUMENTS COMPACTOR /TAMPERS ..... 166

BONE INJECTORS, COLLECTORS & SUCTION TUBE ..... 175

BONE MILL ..... 174

BONE ROUNDER ..... 25

BONE SCRAPER ..... 173

BONE SCRAPER STRAIGHT & CURVED ..... 173

BONE SPOON/PACKER ..... 166

DESCRIPTION PAGE#

BONE THICKNESS GAUGE ..... 146

BONE UNIVERSAL KIT ..... 176

BONE WELL ..... 174

BOX FOR DENTAL IMPLANT TOOLS AND SURGICAL KITS ..... 191

BOX JOINT PLIERS ..... 132,133,134

BRACKET HOLDER TWEEZERS ..... 128

BRACKET PLACER TWEEZERS ..... 128

BRACKET PLACING TWEEZERS ..... 128

BRACKET REMOVING PLIER CURVED ..... 132

BRACKET REMOVING PLIER ROUND BOX ..... 132

BRACKET REMOVING PLIERS ANGLED ..... 136

BRACKET REMOVING PLIERS STRAIGHT ..... 136

BRACKET REMOVING PLIERS WITH PLASTIC TIP ..... 136

BRACKET TWEEZERS SLOT ALIGNER ..... 128

BREWER RUBBER DAM CLAMPS FORCEPS ..... 111

BRUENINGS RETRACTORS ..... 101

BUCCAL AND LINGUAL/PALATAL SCALER ..... 61

BUCCAL DENTAL PHOTOGRAPHIC MIRRORS ..... 98

BUCCAL SURFACES SCALER ..... 61

BUCCAL-SMALL DENTAL PHOTOGRAPHIC MIRRORS ..... 98

BURNISHER FILLING INSTRUMENTS ..... 78,88

BURNISHERS ..... 149

BURNISHERS CONSERVATIVE TREATMENT ..... 68,71

BUSER PERIODONTAL INSTRUMENTS ..... 121

**C**

COSMETIC CONTOURING IMPLANTOLOGY ..... 148

CARBIDE DIAMOND COATED POINT ..... 24

CARRY FORCEPS ..... 170

CARVER COMPOSITE MODELLING INSTRUMENTS ..... 85

CARVERS INSTRUMENTS ..... 89,90

CARVERS INSTRUMENTS CASSETTE FOR 5 INSTRUMENTS ..... 90

CASSETTE FOR INSTRUMENTS ..... 162

CASTROVIEJO CALIPERS ..... 126

CASTROVIEJO GUM SCISSORS ..... 105

CASTROVIEJO MICRO SCISSORS ..... 108

CASTROVIEJO NEEDLE HOLDERS ..... 107,109

CATHETERS TRAY WITH LID BOX WITH FILTER ..... 184

CATRIDGE SYRING ..... 27

CEMENT SPATULAS ..... 95

CERI SAW ..... 124

CHEEK RETAINER ..... 101

CHILD PALATAL DENTAL PHOTOGRAPHIC MIRRORS ..... 98

CHIP BLOWER ..... 116

CHISELS, BONE FILES & SPOONE CURETTE ..... 138

CHISELS SCALER ..... 65,67

CHOMPRET ROOT ELEVATOR ..... 42

CINCH BACK / TIE BACK DISTAL END BENDING PLIERS ..... 137

CLAW-LIFT ROOTS ELEVATOR ..... 37

COARSE SUCTION TUBES ..... 178

COBRA IMPLANTOLOGY ..... 156

COHEN UNIVERSAL EXTRACTING FORCEPS (AMERICAN PATTERN) ..... 17

COLLEGE FORCEPS ..... 51

COLLEGE TWEEZER ..... 53

COLLEGE WITH LOCK TWEEZERS ..... 52

COLLINS TONGUE FORCEPS ..... 110

COLUMBIA RETRACTOR ..... 99

COMBINATION RETRACTORS ..... 101

COMELLAS FORCEPS ANATOMICAL HANDLE ..... 26

COMPASSO DE WILLIS ..... 127

COMPOSITE BALL PLUGGERS ..... 76

COMPOSITE FILLING INSTRUMENTS ..... 92,93

COMPOSITE FILLING INSTRUMENTS SET OF 6 PCS ..... 153

COMPOSITE GOLD TIP INSTRUMENTS ..... 93

COMPOSITE INSTRUMENTS ..... 72,73

COMPOSITE INSTRUMENTS BLUE TITANIUM WITH CASSETTES ..... 89

COMPOSITE INSTRUMENTS TITANIUM BLUE ENDODONTIC ..... 89

COMPOSITE MODELLING INSTRUMENTS ..... 85

COMPOSITE PLUGGERS INSTRUMENTS ..... 82,83

COMPOSITE/PLASTIC FILLING INSTRUMENTS ..... 87

CONDENSER IMPLANTOLOGY ..... 150,161

CONE-SOCKET MOUTH MIRRORS ..... 49

CONE-SOCKET FRONT SURFACE MOUTH MIRRORS ..... 49

CONE-SOCKET MIRROR HANDLES FOR MOUTH MIRRORS ..... 50

CONE-SOCKET PLAIN MOUTH MIRRORS ..... 49

CONE-SOCKET RHODIUM MOUTH MIRRORS ..... 49

CONE-SOCKET SOLID HANDLES FOR MOUTH MIRRORS ..... 50

CONE-SOCKET SOLID OCTAGONAL HANDLES FOR MOUTH MIRRORS ..... 50

CONTOURING PLIER ..... 134,138

COPERCHIO HOLLOWARE INSTRUMENTS ..... 145

CORROSION-RESISTANT ..... 186

COTTON HOLDER ..... 186

COTTON HOLDING JAR ..... 186

COTTON WOOL DISPENSER ACC. TO METHOT ..... 186

COUPLAND ROOT ELEVATORS ..... 34

CRANE KAPLAN TWEEZERS ..... 53

CRILE-WOOD NEEDLE HOLDERS ..... 106,107

CROWN REMOVER ..... 114

CROWN SPREADERS ..... 114

CRUCIBLE TONGS ..... 124

CRUYER EXTRACTING FORCEPS (AMERICAN PATTERN) ..... 12,13,19,20

CRUYER ROOT ELEVATORS ..... 32

CUTTER ..... 139,142

CUTTER, UTILITY PLIERS & WIRE FORMING PLIERS ..... 141

**D**

DEAN GUM SCISSORS ..... 105

DEBAKEY ATRAUMATIC TISSUE FORCEPS ..... 166

DELUX BOLEY GAUGE ..... 127

DELUXE BRACKET HOLDER ..... 128

DELUXE BRACKET HOLDER TWEEZERS ..... 128

DENHARD RETRACTORS - MOUTH GAGS ..... 100

DENTAL PHOTOGRAPHIC MIRRORS ..... 98

DENTAL SYRINGES ..... 27

DENTAURUM CALIPER ..... 127

DERF NEEDLE HOLDERS ..... 106,107

DETAILING STEP PLIER ..... 139

DETAILING STEP PLIERS / BAYONET BENDING PLIERS ..... 137

DIAMOND COATED MARGIN TRIMMERS ..... 65

DIRECT BOND BRACKET HOLDER TWEEZERS ..... 128

DIRECT BOND BRACKET HOLDER TWEEZERS, SMALL TIP ..... 128

DIRECT BONDING BRACKET HOLDERS ..... 128

DIRECT BRACKET REMOVER TC ..... 140

DISC SYSTEM DENTAL SYRINGES ..... 27

DISSECTING SET SET OF 11 PCS ..... 94

DISSECTING SET SET OF 9 PCS ..... 94





# INDEX

## DESCRIPTION PAGE#

DISTAL AMALGAM CARRIERS	117
DISTAL BENDER SILICON GRIP	129
DISTAL CUTTER	139
DISTAL END CUTTER	135
DISTAL END CUTTER FLUSH CUT	142
DISTAL END CUTTER, SAFETY HOLD PLIER (IDEAL FOR CUTTING WIRE) TC	140
DISTAL END, WIRE CUTTERS & BRACKET REMOVER PLIERS	140
DISTAL SCALER	51,63
DOUBLE ENDED CEMENT SPATULA	131
DOUBLE ROUNDED JAW BENDING PLIERS	138
DOUBLE ENDED EXPLORERS	54
DRESSING TWEEZERS	52,53
DYNAMOMETER	146

<b>E</b>	
EASY ACCESS TWEEZES	128
EBMETER SCALER	64
ELASTIC INSTRUMENT SILICON GRIP	129
ELASTIC SEPARATING PLIER	140
ELASTIC SEPARATING PLIER ROUND HANDLE	140
ELASTOMERIC LIGATURE PLACING FORCEPS WITH GROOVE FALCON	140
ELEVATORS SET OF 8 PCS	46
ELEVATORS SET OF 8 PCS	46
ELLIOT SIQVELAND RETAINERS	115
ENDO FINGER RULER SPAN MEASURE SCALE	125
ENDODONTIC BOX	186
ENDODONTIC EXPLORER	154
ENDODONTICS INSTRUMENTS	58
ERGO GRIP RETRACTOR	101
EURO BREECH LOADING DENTAL SYRINGES	27
EXAVATORS EXPLORERS	51
EXCAVATOR INSTRUMENTS	74
EXCAVATORS	86
EXECT BRACKET HOLDER TWEEZERS	128
EXPLORERS	51,54,55,56
EXTRACTING FORCEPS (AMERICAN PATTERN)	12to24
EXTRACTING FORCEPS (ENGLISH PATTERN)	01to07,26

EXTRACTING FORCEPS (ENGLISH PATTERN) SET OF 10 PIECES	07
EXTRACTING FORCEPS	08
EXTRACTING FORCEPS AMERICAN ADULT SET OF 10 PCS	28
EXTRACTING FORCEPS AMERICAN ADULT SET OF 8 PCS	28
EXTRACTING FORCEPS CHILDREN PATTERN SET OF 10 PIECES	28
EXTRACTING FORCEPS ENGLISH ADULT SET OF 10 PCS	28
EXTRACTING FORCEPS ENGLISH ADULT SET OF 10 PCS	28
EXTRACTING FORCEPS PEDO SET OF 7 PCS	28
EXTRACTING FORCEPS SET	28
EXTRACTING FORCEPS SET OF 10 PIECES	28
EXTRACTING FORCEPS SET OF 10 PIECES	28
EXTRACTING FORCEPS SET OF 10 PIECES	28
EXTRACTING FORCEPS SET OF 13 PIECES	28
EXTRA-FLEX IMPLANTOLOGY	147

<b>F</b>	
FALCON BEAK CONTOURING PLIERS	133,138
FARABEUF RETRACTORS SET OF 2 PIECES)	103
FELDMAN RETRACTOR	103
FILING INSTRUMENTS (GOLD POINTED)	91
FILING INSTRUMENTS	87,88,91,93
FILING INSTRUMENTS CONSERVATIVE TREATMENT	69,70,75,78,79,81,84
FIRST AID EXAMINATION SET OF 3 PIECES	51
FLEXIBLE PERITOME	163
FLEXI-THIN IMPLANTOLOGY	147
FLOHR ROOT ELEVATORS	29,33
FLUSH-CUT DISTAL AND CUTTING PLIERS	133
FLUSH-CUT DISTAL END CUTTER	135
FOERSTER DRESSING FORCEPS	110
FRAZIER SUCTION TUBES WITH FILTER	178
FREEDMAN "DUCKHEAD"	149
FREEDMAN BURNISHERS	149
FREEDMAN LARGE CONTACT FORMING	149
FREEDMAN SMALL CONTACT FORMING	149
FREER PERIODONTAL INSTRUMENTS	121
FREER PERIOSTEEL ELEVATORS	120
FRET SAW	124
FRIEDMAN BONE ROUNDER	25
FRIEDMANN ROOT ELEVATOR	36
FRIEDMANNRICHARD PERIODONTAL INSTRUMENTS	122
FUZZI COMPOSITE MODELLING INSTRUMENTS	85

<b>G</b>	
GERALD TWEEZERS	52
GILLES TWEEZERS	52
GILLES NEEDLE HOLDER WITH SCISSORS	107
GLOVES BOX	184
GOLD COLOR SET DENTAL ORAL IMPLANTOLOGY SINUS SET OF 10 PCS WITH CASSETTE	156
GOLD MILL (LARGE)	174
GOLD MILL (SMALL)	174
GOLDMAN FOX SUPER CUT SCISSORS	108
GOLDMAN FOX EXPLORERS	55
GOLDMAN FOX SCISSORS	108
GOLDMAN-FOX GUM SCISSORS	104,105
GOLDMAN-FOX PERIODONTAL INSTRUMENTS	121
GOLDMANN-FOX SCALER	64
GRACEY AFTER FIVE	60
GRACEY CURETTES SCALER	61
GRACEY CURETTES	59,63
GRACEY MINI FIVE	60
GRACEY SCALER	61
GRAFT MATERIAL SPOON CONCAVE TIP FOR LARGER GRAFTS	165
GRAFT PACKER	166
GRAFT PACKER, CONCAVE	166
GRIPPER CARBIDE TIPPED TISSUE FORCEPS TC	169
GRITMAN CEMENT SPATULAS	95
GROSS MAIER DRESSING FORCEPS	110
GULDENER SCALER	64
GUM SCISSORS	104to108

<b>H</b>	
HAEMOSTATIC FORCEPS & TOWEL CLAMPS	110
HALSEY NEEDLE HOLDERS	106,107
HALSTEAD MOSQUITO HAEMOSTATIC FORCEPS	110
HALSTEAD MOSQUITO NEEDLE HOLDERS	107
HALTEPINZETTE WITH LOCK TWEEZERS	170

## DESCRIPTION PAGE#

HAMMER HEAD DISTAL END BENDING PLIERS	137
HAMMER WITH WOODEN HANDLE	124
HANDLE ROUND HANDLES FOR MOUTH MIRRORS	50
HANDLES FOR MOUTH MIRRORS	50
HARD WIRE CUTTER	142
HARD WIRE CUTTER STRAIGHT	142
HARD WIRE CUTTER, 15° ANGLED	135
HARD WIRE CUTTER, 15° ANGLED NON-AUTOCALAVABLE	135
HARD WIRE CUTTER, STRAIGHT	140
HARD WIRE CUTTERS	140
HARRIS EXTRACTING FORCEPS (AMERICAN PATTERN)	13,18
HARTMANN (BABY MOSQUITO) NEEDLE HOLDERS	107
HEAT CARRIERS	57
HEBER BAYONET ROOTS ELEVATOR	40
HEBER ROOTS ELEVATOR	40
HEIDBRINK ROOT APPEX ELEVATOR	44
HEIDBRINK ROOT ELEVATORS	33,43
HEIDBRINK ROOTS ELEVATOR WARWICK-JAMES	44
HEIDEMANN FILLING INSTRUMENTS	93
HEIDEMANN SPATULAS	73
HEIGHT GAUGE 0.18 STAINLESS STEEL	125
HEIGHT GAUGE ALUMINUM	125
HEMINGWAY TWEEZERS	53
HEX TORQUE WRENCH UNIVERSAL	177
HEXAGONAL HANDLES FOR MOUTH MIRRORS	50
HIRSCHFELD PERIODONTAL INSTRUMENTS	122
HIRT COMPOSITE MODELLING INSTRUMENTS	85
HIRT COMPOSITE PLUGGERS INSTRUMENTS	83
HIRT SCALER	66
HMG HEISTER	99
HOLLENBACK FILLING INSTRUMENTS	80,87
HOLLOW CHOP CONTOURING PLIERS	143
HOLLOW HANDLES FOR MOUTH MIRRORS	50
HOLLOW MIRROR HANDLES FOR MOUTH MIRRORS	50
HOLLOWWARE INSTRUMENTS	183,184,186,187,190,191
HOLZ SCALER	65
HOOK CRIMPING PLIER ANGLED STRAIGHT TC	140
HOOK KNIVES	96
HOPSON FILLING INSTRUMENTS	78
HOW PLIER	132
HOW PLIER CURVED	132
HOW PLIERS OFFSET	141
HOW PLIERS STRAIGHT	141
HOW STRAIGHT UTILITY PLIERS	136
HOWARD PERIOSTEEL ELEVATORS	120
HULL EXTRACTING FORCEPS (AMERICAN PATTERN)	19
HYLIN CEMENT SPATULAS	95
HYLIN ROOTS ELEVATOR	39

<b>I</b>	
IMPLANT GAGES	145
IMPLANT SINUS LIFT INSTRUMENTS	161,162
IMPLANTOLOGY	145to178
IMPLANTOLOGY 9 PCS OF SET	161
IMPLANTOLOGY SET OF 2 COMPOSITE BLUE TIP INSTRUMENTS	154
IMPLANTOLOGY SET OF 3 COMPOSITE BLUE TIP INSTRUMENTS	154
IMPLANTOLOGY SET OF 4 COMPOSITE BLUE TIP INSTRUMENTS	154
IMPLANTOLOGY SET OF 5 COMPOSITE GOLD TIP INSTRUMENTS	154
IMPRESSION TRAYS	179to182
IMPRESSION TRAYS PERFORATED FULL DENTURE SET OF 8 PCS	181
IMPRESSION TRAYS PERFORATED WITHOUT RIM LOCK	182
IMPRESSION TRAYS SOLID FULL DENTURE SET OF 08 PCS	181
IMPRESSION TRAYS SOLID FULL DENTURE SET OF 8 PCS	182
IMPRESSION TRAYS SOLID WITH RIM LOCK	182
IMPRESSION TRAYS SOLID WITH RIM LOCK SET OF 06 PCS	180
IMPRESSION TRAYS SOLID WITH RIM LOCK SET OF 08 PCS	180
IMPRESSION TRAYS SOLID WITH RIM LOCK SET OF 10 PCS	180
INSTRUMENTS BOX	184
INSTRUMENTS BOX PERFORATED	184
INSTRUMENTS BOX WITH HOOKS	184
INSTRUMENTS BOX WITH LID	184
INSTRUMENTS CASSETTE 10 HINGED	191
INSTRUMENTS CASSETTE 10 PIECES CASSETTE	191
INSTRUMENTS CASSETTE 15, SURGERY KIT	191
INSTRUMENTS CASSETTE	191
INSTRUMENTS CASSETTE 20 DETACHABLE	191
INSTRUMENTS CASSETTE 20 DETACHABLE LIDS	191
INSTRUMENTS CASSETTE 20 HINGED	191
INSTRUMENTS CASSETTE 5 DETACHABLE LIDS	191
INSTRUMENTS CASSETTE 5 INHINGED LIDS WITH BUTTON LOCK	191
INSTRUMENTS CASSETTE 5 PIECES CASSETTE	191
INSTRUMENTS CASSETTE 7 INHINGED	191
INSTRUMENTS CASSETTE 7 PIECES CASSETTE	191
INSTRUMENTS TRAY PERFORATED	183,181
INSTRUMENTS TRAY PERFORATED BASE	191
INSTRUMENTS TRAY SOLID BASE	191
INSTRUMENTS TRAYS	183
INSTRUMENTS TRAYS WITH COVER	184
INSTRUMENTS TRAYS WITH LID	183
INSTRUMENTS TRAYS WITHOUT COVER	184
INTRALIGAMENTAL ANESTHESIA SYRINGE	27
IRIS GUM SCISSORS	104
IRIS SUPER CUT SCISSORS	104,108
IRIS GUM SCISSORS	104,105,108
IVORY SIQVELAND RETAINERS	115
IVORY LIGHT WEIGHT RUBBER DAM CLAMPS FORCEPS	111
IVORY MATRIX RETAINERS	115
IVORY RETRACTORS	101
IVORY RUBBER DAM CLAMPS FORCEPS	111
IWANSON SPRING CALIPER FOR METAL AND PORCELAIN	126
IWANSON SPRING CALIPER FOR WAX	126

<b>J</b>	
JAQUETTE SCALER	63
JARABAK PILERS	143
JECT ULTIMA DENTAL SYRINGES	27
JENNINGS RETRACTORS - MOUTH GAGS	100
JOHNSON CONTOURING PLIERS	133
JOHNSON PLIERS FOR CROWN BAND CONTOURING	138
JONES TOWEL CLAMPS	110
JOSEPH GUM SCISSORS	105

<b>K</b>	
KALT NEEDLE HOLDERS TC	109
KELLS EXTRACTING FORCEPS (AMERICAN PATTERN)	15





DESCRIPTION	PAGE#
KELLY GUM SCISSORS	104,105
KELLY HAEMOSTATIC FORCEPS	110
KELLY-RANKIN HAEMOSTATIC FORCEPS	110
KEY RINGS	94
KEYS FOR IMPLANT SCREW	177
KILNER (RAGNELL) GUM SCISSORS	105
KIRKLAND SCALER	84
KLEIN EXTRACTING FORCEPS	08
KLEINERT-KUTZ BONE ROUNDING	25
KOPP ROOTS ELEVATOR	39
KRAMER NEVINS SINUS LIFT	162
KRAMER-NEVINS PERIODONTAL INSTRUMENTS	121
KRAMER-NEVINS BONE CHISEL	119
KUEHNE TWEEZERS	170
<b>L</b>	
LA GRANGE NEEDLE HOLDERS	109
LA GRANGE GUM SCISSORS	104,105
LADMORE FILLING INSTRUMENTS	88
LADMORE IMPLANTOLOGY	149
LAGRANGE SCISSORS	108
LAGRANGE SUPER CUT SCISSORS	108
LANGENBECK RETRACTORS	103
LANGER SCALER	63
LAP & L-KEY JOINT PLIERS	139
LARGE FLUCH-CUT DISTAL AND CUTTING PLIERS	133
LAXUTOR ROOT ELEVATORS	30,31
LAXUTOR ROOT ELEVATORS SET OF 9 PCS	38
LE CRON CEMENT SPATULAS	95
LECLUSE BAYONET ROOT ELEVATOR	41
LESSMANN WAX KNIVES	96
LICHTENBERG-RYDER T.C NEEDLE HOLDERS	109
LIGATURE FORMING PLIERS	134
LIGATURE INSTRUMENT SILICON GRIP	129
LIGHT WORE BIRD BEAK PLIERS WITH GROOVE	143
LINDO LEVIAN ROOT ELEVATORS	35
LINGUAL / PALATAL ARCH FORMING PLIERS	134
LINGUAL ARCH FORMING PLIERS	143
LINGUAL DENTAL PHOTOGRAPHIC MIRRORS	98
LINGUAL/PALATAL SURFACES SCALER	61
LINGUAL-LARGE DENTAL PHOTOGRAPHIC MIRRORS	98
LIP & CHEEK RETRACTOR	100
L-KEY JOINT PLIERS	139to138
LOCKLIN GUM SCISSORS	105
LONDON COLLEGE TWEEZERS	52
LONDON HOSPITAL	34
LONG IMPLANT DRILLS	176
LOOP FORMING IN FOUR LENGTH	138
LORNHAEMOSTATIC FORCEPS	110
LUCAS IMPLANTOLOGY	168
LUER BONE ROUNDING	25
LUXS	58
LUXATING ELEVATOR / PERIOTOME	36
LUXATING ELEVATOR WITH PERIOTOME TIP	36
LUXATOR ROOT ELEVATORS	29
LUXATOR/ELEVATOR 8 PCS	191
LUXATORS SET OF 7 PCS	46
LUXATORS SET OF 7 PCS	46
LUXATORS SET OF 8 PCS	46
LUXIER ROOTS ELEVATOR	40
LUXIVATORS CURVED ATRAUMATIC LUXATION OF THE TOOTH	48
LUXIVATORS STRAIGHT ATRAUMATIC LUXATION OF THE TOOTH	48
<b>M</b>	
MAGNIFYING MOUTH MIRRORS	49
MALLET IMPLANTOLOGY	174
MALLETS - PLASTER SHEARS - SAWS & BLADES	124
MANUAL ASPIRATING SYRINGE	27
MANUAL CROWN REMOVERS	114
MARGIN TRIMMERS	66
MARGINAL RIDGE & EMBRASURE SHAPING INSTRUMENT	148
MARKLEY FILLING INSTRUMENTS	93
MARQUETTE CONDENSER	87
MARQUETTE PLUGGERS	87
MARYAM TWEEZERS	53
MATHIEU NEEDLE HOLDERS	107
MATRIX RETAINERS	115
MAXI HOLLOWWARE INSTRUMENTS	187
MAYO GUM SCISSORS	104
MAYO NEEDLE HOLDERS	106
MAYO TRAY PERFORATORS	183
MAYO-HEGAR NEEDLE HOLDERS	106,107
MCCALL SCALER	63
MEAD BONE ROUNDING	25
MEAD NON AUTO CLAVABLE PLASTIC TIPS	119
MEASURING LOOP	126
MEASURING LOOP, CASTROVIEJO	126
MEASURING PROBE	145
MEISSNER EXTRACTING FORCEPS	26
MEMBRANE IMPLANTOLOGY	161
MEMBRANE 3POSITIONING IMPLANTOLOGY	150
MEMBRANE DETACH ELEVATOR	164
MEMBRANE ELEVATOR	164
MEMBRANE TWEEZERS	170
MERRIAM TWEEZERS	52
MERRITT B EXPLORERS	55
MERTSON BAND PUSHER	129
MESH CASSETTES 5 PIECES, 7 PIECES, 10 PIECES, 15PIECES & 20 PIECES	190
MESH TRAY	190
MESH TRAYS 05 PCS	190
MESH TRAYS 07 PCS	190
MESH TRAYS 10 PCS	190
MESH TRAYS	190
MESH TRAYS 20 PCS	190
MESIAL SCALER	61
METZENBAUM GUM SCISSORS	104,106
MICOR ADSON 1X2 TISSUE FORCEPS	169
MICRO BOLEY GAUGE STRAIGHT	146
MICRO BOLEY GAUGE TWISTED	146
MICRO IRIS GUM SCISSORS	104
MICRO SURGICAL SCALPEL HANDLE TITANIUM	123
MICRO-FRIEDMAN BONE ROUNDING	25
MICRO-MINI PIN & LIGATURE CUTTER	142
MIDDELBORPF RETRACTORS	103
MILLER BONE FILES	119
MILLER ROOT ELEVATORS	37

DESCRIPTION	PAGE#
MILLER IMPLANTOLOGY	168
MILLER ROOT PLANNING FILES	119
MILLER TWEEZERS	53
MINI DISTAL AMALGAM CARRIERS	117
MINI GAUGE	127
MINI LIGATURE CUTTERS	133
MINI PIN & LIGATURE CUTTER	142
MINI PIN & LIGATURE CUTTER TC	139
MINI-LANGENBECK RETRACTORS	102
MINI-SPATEL BURNISHERS	71
MINNESOTA RETRACTORS	101
MIRROR EXPLORERS	51
MIRROR HANDLE STEM WITH RULE HANDLES FOR MOUTH MIRRORS	50
MISCELLANEOUS PRODUCTS	94
MIXING SPATULA WITH SHOVEL	165
MOLT 9 PERIODONTAL INSTRUMENTS	121
MOLT AUTO CLAVABLE PLASTIC TIPS	119
MONARI COMPOSITE MODELLING INSTRUMENTS	85
MORTENSON FILLING INSTRUMENTS	80,87
MOUTH MIRROR EXPLORERS	51
MOUTH MIRRORS	49
MOUTH PROPS	94
MOVEABLE HEIGHT GAUGE	125
MSY CEMENT SPATULAS	95
MÜHELMANN SCALER	64,65
MULTIFUNCTIONAL METER	145
MULTI-PURPOSE PLIERS	137
<b>N</b>	
NAKAWALNI DENTAL LABORATORY INSTRUMENT	97
NANCE LOOP FORMING PLIERS	132,137
NAPKIN HOLDER WITH METAL CHAIN	94
NAPKIN HOLDER WITH PLASTIC CHAIN	94
NARROW SIOVELAND RETAINERS	115
NEEDLE HOLDERS	106to109
NEEDLE STERILIZATION TUB	186
NEUMANN GUM SCISSORS	105
NEVINS EXTRACTING FORCEPS (AMERICAN PATTERN)	14,16
NORMAL HANDLE EXPLORERS	54
NOYES GUM SCISSORS	105
<b>O</b>	
OBTUSE IMPLANTOLOGY	161
OCCUSAL ANATOMY INSTRUMENT	148
OHIL PERIOSTEEL ELEVATORS	120
OLSEN-HEGAR NEEDLE HOLDER WITH SCISSORS	107
OMEGA LOOP FORMING PLIERS	141
ORBAN SCALER	64
ORTHO BAND PUSHER SCALER	131
ORTHO INSTRUMENT	130
ORTHO LIGATURE DIRECTOR SINGLE ENDED	131
ORTHO LIGHT BAND PUSHER SCALER	129
ORTHO LIGHT DOUBLE ENDED LIGATURE	131
ORTHO LIGHT DOUBLE ENDED LIGATURE DIRECTOR	131
ORTHO LIGHT DOUBLE ENDED LIGATURE DIRECTOR SCALER	129,131
ORTHO LIGHT DOUBLE ENDED LIGATURE SCALER	131
ORTHO LIGHT LIGATURE DIRECTOR DOUBLE ENDED	131
ORTHO LIGHT SCALER	130
ORTHO LIGHT SCALER DOUBLE ENDED	130
ORTHO LIGHT SCALER HEAVY	130
ORTHO LIGHT SCALER SINGLE ENDED	131
ORTHO RULER / CONE SOCKET	146
ORTHODONTIC INSTRUMENTS	125to131
ORTHODONTICS PLIERS STANDS	144
ORTHOLITE LIGATURE DIRECTOR SCALER	131
OSTEOMETER MEASURING FORCEPS FOR JAW	146
OSTEOTOME CONVEXES / CONCAVE / CONIQUES	171,172
OSTEOTOME CONVEXES / CONCAVE / CONIQUES SET OF 5 PIECES	172
<b>P</b>	
P.K. THOMS WAXING INSTRUMENTS KIT	89
P.K. THOMS WAXING INSTRUMENTS SOLID HANDLE	89
PALATAL-ADULT DENTAL PHOTOGRAPHIC MIRRORS	98
PALATAL-ADULT LARGE DENTAL PHOTOGRAPHIC MIRRORS	98
PALATAL-CHILD DENTAL PHOTOGRAPHIC MIRRORS	98
PALMER RUBBER DAM CLAMPS FORCEPS	111
PARMLY EXTRACTING FORCEPS (AMERICAN PATTERN)	16
PARTSCH PERIOSTEEL ELEVATORS	120
PDL ELEVATORS	47,48
PDL ELEVATORS SET OF 7 PCS	47
PDL ELEVATORS SET OF 7 PCS	47
PDL ELEVATORS SET OF 8 PCS	48
PEDIATRIC TOOTH EXTRACTING FORCEPS SET	08
PEET SPLINTER FORCEPS	109
PERFORATED WITH RIM LOCK SET OF 06 PCS	179
PERFORATED WITH RIM LOCK SET OF 10 PCS	179
PERFORATED WITH RIM LOCK SET OF 8 PCS	179
PERIODONTAL CHISELS	118
PERIODONTAL INSTRUMENTS	120to122
PERIODONTAL KNIVES	64
PERIODONTAL PROBES	58
PERIODONTAL PROBESSPREADERS	57
PERIODONTAL SURGERY	162
PERIOSTEEL	
ELEVATORS	120,154
PERIOTOME ROOTS ELEVATOR	43
PERRY TWEEZERS	52,53
PHYSIC EXTRACTING FORCEPS (AMERICAN PATTERN)	16
PIN & LIGATURE CUTTER	142
PIN & LIGATURE CUTTERS TC	139
PIN HOLDING PLIER TC	140
PIN-TWEEZERS	170
PLAIN MOUTH MIRRORS	49
PLANATOR	69
PLANATOR	69
PLASTER KNIFE	96
PLASTER SHEARS	124
PLASTIC FILLING INSTRUMENTS	93
PLIER STAND PLASTIC	144
PLIER STAND STAINLESS STEEL	144
PLIERS FOR ORTHODONTICS & PROSTHETICS	132to143
PLIERS STAND STAINLESS ROD (ALUMINUM ANODIZED)	144
PLUGGERS	56
PLUGGERS/CONDENSERS	87
POSITIONING 3 IMPLANTOLOGY	161





# INDEX

## DESCRIPTION PAGE#

POSITIVE POSTIONER .....	125
POSTERIOR BAND REMOVING PLIERS - LONG .....	141
POSTERIOR BAND REMOVING PLIERS - SHORT .....	141
POTTS 'T-HANDLE' ELEVATOR-LEFT .....	41
POTTS 'T-HANDLE' ELEVATOR-RIGHT .....	41
PRICHARD PERIODONTAL INSTRUMENTS .....	121
PROBE EXPLORERS .....	51
PRONG 3 CLASP ADJUSTABLE PLIER TC. ....	140
<b>Q</b>	
QUATRO DENTAL SYRINGES .....	27
<b>R</b>	
RASPATOR, PRICHARD .....	165
RASPATOR, RASPATORY .....	120
RASPATOR, WILLIGER .....	120
RECTANGULAR ARCH BENDING PLIERS .....	143
RETRACTOR SELDIN .....	103
RETRACTORS - MOUTH GAGS .....	99,100
RETRACTORS .....	101to103
RHODIUM MOUTH MIRRORS .....	49
RIBBON RETRACTORS .....	101
RIDGE MAPPING DOUBLE CALIPER .....	146
RING 2 DENTAL SYRINGES .....	27
ROCHESTER-KOCHER HAEMOSTATIC FORCEPCS .....	110
ROCHESTER-PEAN HAEMOSTATIC FORCEPCS .....	110
ROOT CANAL PLUGGER .....	56
ROOT ELEVATOR .....	296to48
ROOT ELEVATORS SET OF 10 PCS .....	46
ROOT FRAGMENT FORCEPCS .....	09,11
ROOT PICK ELEVATOR WITH GOLD FLEXIBLE POINTS .....	42
ROOT PLANNING FILES .....	119
ROOT PLANNING FILES & BONE FILES .....	119
ROOTS SPLINTER FORCEPCS .....	10
ROSER-KÖNIG RETRACTORS - MOUTH GAGS .....	100
ROUND AND CONCAVE PLIER .....	139
ROUND ENDODONTIC BOXES .....	186
ROUND EXCAVATOR .....	86
ROUND TORQUE WRENCH UNIVERSAL .....	177
ROUTURIER EXTRACTING FORCEPCS (ENGLISH PATTERN) .....	03
ROUTURIER EXTRACTING FORCEPCS FOR LOWER MOLARS .....	03
RUBBER DAM CLAMPS .....	113
RUBBER DAM CLAMPS FORCEPCS .....	111
RUBBER DAM CLAMPS KITS .....	112
RUBBER DAM FRAME .....	112
RUBBER DUM TEMPLATE .....	112
RULER .....	127
RULER WEDGE .....	127
RUSSIAN LONG TISSUE FORCEPCS .....	170
RUSSIAN TISSUE FORCEPCS .....	170
RYDER NEEDLE HOLDERS .....	106,107
<b>S</b>	
SAW BLADES .....	124
SCALER .....	59to67
SCALERS TRAYS .....	183
SCALPEL HANDLE STRAIGHT .....	123
SCALPEL HANDLES .....	123
SCHLEMMER ROOTS ELEVATOR .....	37
SCHMIDLIN PERIODONTAL INSTRUMENTS .....	122
SCHURE BAND SEATER .....	130
SCHWARTZ PLIERS .....	139
SEPARATING ELASTIC PLIER .....	111
SELDIN PERIODONTAL INSTRUMENTS .....	122
SELDIN ROOT ELEVATORS .....	29,32
SELF LOCKING GROOVED .....	169
SELF-LOCKING TWEEZER .....	53
SEMKEN TAYLOR TWEEZERS .....	52
SENN MUELLER RETRACTOR .....	102
SERRATED PLUGGERS .....	84
SET OF 5 PIECES .....	171
SHEPHERD'S HOOK EXPLORER .....	54
SHORT IMPLANT DRILLS .....	176
SICKLE SCALERS .....	63
SIMPLEX RETRACTOR .....	100
SINUS ELEVATOR & MEMBRANE LIFT TIPS .....	164
SINUS IMPLANTOLOGY .....	156,161
SINUS LEFT ELEVATOR & MEMBRANE LIFT TIPS 3 SET OF 7 PCS .....	164
SINUS LEFT ELEVATOR SET OF 10 PCS .....	158
SINUS LIFT ELEVATOR .....	151,157
SINUS LIFT ELEVATORS SET OF 7 PCS WITH CASSETTE .....	157
SINUS LIFT INSTRUMENT .....	150to152,161
SINUSLIFT IMPLANTOLOGY .....	150,161
SIOVELAND RETAINERS .....	115
SLIM WEINGART PLIERS .....	141
SLIPPER TWEEZERS .....	128
SMAHA ELASTOMERIC LIGATURE PLACING FORCEPCS .....	140
SMALL/MEDIUM BALL BURNISHER .....	149
SOFT BRUSHING KIT SET OF 6 PCS .....	163
SOFT WIRE AND LIGATURE CUTTER .....	135
SOFT WIRE AND LIGATURE CUTTER, STANDARD .....	135
SPATULAS .....	73
SPATULAS ROUNDED AND SHARP .....	72
SPECIAL INOX .....	124
SPECIAL INOX WAX KNIVES .....	96
SPENCER GUM SCISSORS .....	105
SPIRIT LAMP .....	186
SPLINTER FORCEPCS .....	10
SPOON AND PUSHER (TRINOVO) .....	139
STANDARD LIGATURE CUTTER TC. ....	167
STAR TORQUE WRENCH UNIVERSAL .....	177
STERILIZING BOXES & INSTRUMENTS TRAYS .....	184
STERILIZING MESH TRAY .....	190
STERNBERG RETRACTORS .....	99
STIEGLITZ ROOT FRAGMENTS .....	10
STIEGLITZ SPLINTER FORCEPCS .....	10
STOCKES RUBBER DAM CLAMPS FORCEPCS .....	111
STOP PLIERS V-BEED .....	137
STRAIGHT DIRECT BOND BRACKET REMOVER TC. ....	140
STRIP SAW .....	125
SUCTION CANNULA KIT WITH 3 NEEDLES .....	178
SUCTION NEEDLE .....	178
SUCTION PIPE .....	178
SUCTION TUBES .....	178
SURGICAL TWEEZERS .....	52

## DESCRIPTION PAGE#

SURGICAL BALL HOOK CRIMPING PLIERS, ANGLED .....	137
SURGICAL BALL HOOK CRIMPING PLIERS, STRAIGHT .....	137
SURGICAL CHISELS .....	162
SUTURE PLIERS SUTURE FORCEPCS .....	169
SWEDISH TYPE DENTAL SYRINGES .....	27
SYNDEMOTOMES ROOTS ELEVATOR .....	43
<b>T</b>	
TAMPER .....	166
TANNER FILLING INSTRUMENTS .....	88
TARTAR REMOVER INSTRUMENTS SOLID HANDLE .....	67
TAYLOR SCALER .....	63
THICK EXPLORERS .....	54
THREE JAW PLIERS .....	143
TISSUE GRAFT FORCEPC SERRATED TEETH .....	169
TISSUE MEMBRANE FORCEPCS .....	169,170
TISSUE PUNCH .....	173
TISSUE PUNCH FORCEPCS TO REMOVE TISSUE AFTER USING PUNCH .....	170
TISSUE PUNCH SET OF FIVE PIECES .....	173
TISSUE PUNCH STRAIGHT & CURVED .....	173
TISSUE PUNCH WITH PIN SET OF FOUR PIECES .....	173
TITANIUM LOCKING PLIER .....	169
TITANIUM PERIOSTEAL ELEVATOR FOR IMPLAN .....	122
TOFFLEMIRE-JUNIER SIOVELAND RETAINERS .....	115
TOFFLEMIRE-SENIOR SIOVELAND RETAINERS .....	115
TOMAS EXTRACTING FORCEPCS (AMERICAN PATTERN) .....	17,22
TONNIS NEEDLE HOLDERS .....	109
TORQUE WRENCH & RATCHET .....	177
TORQUING PLIERS SET .....	137
TOWNER-JAQUETTE SCALER .....	63
TREPHINE .....	175
TREPHINE DRILL SET OF EIGHT PIECES .....	175
TRINOVO HANDLE .....	167
TRIO DENTAL SYRINGES .....	27
TRIPLE-ANGLED BACK ACTION EXCAVATOR .....	86
TWEED / ANGEL FORMING AND TORQUING PLIERS .....	134
TWEED / ANGEL RECTANGULAR ARCH FORMING AND .....	
TORQUING PLIERS .....	137
TWEED / ANGLE RECTANGULAR ARCH FORMING & TORQUING PLIERS .....	133
TWEED LOOP FORMING PLIERS .....	132,133,143
TWEEZERS .....	52,53
TWEEZERS EXPLORERS .....	51
TWEL-ON ELASTIC MODULE INSTRUMENT .....	130
TYPE C DENTAL SYRINGES .....	27
<b>U</b>	
UNIQUE RETRACTORS .....	102
UNIVERSAL CROWN REMOVER .....	114
UNIVERSAL CURETTES .....	63
UNIVERSAL CUT & HOLD DISTAL END CUTTER .....	142
UNIVERSAL DOLPHIN STYLE WIRE BENDING & CUTTING PLIERS .....	132
UNIVERSAL EXTRACTING FORCEPCS (AMERICAN PATTERN) .....	22
UNIVERSAL MINI-ELEVATOR FOR FRAGMENTS .....	34
UNIVERSAL NEEDLE HOLDERS .....	106
UNIVERSITY OF MICHIGAN EXPLORERS .....	55
UNIVERSITY OF NORTH CAROLINA EXPLORER .....	55
UPPER ROOT ELEVATOR WITH HELICOIDAL TIP .....	31
US ARMY RETRACTORS .....	102
UTILITY PLIER WEINGART TC. ....	140
<b>V</b>	
V BEND STOP .....	139
V BEND STOP PLIER TC. ....	139
VERNIER GAUGE .....	127
VISTA TUNNELING INSTRUMENTS SET .....	155
<b>W</b>	
W BARRY ROOTS ELEVATOR .....	41
WAHL BONE FILES .....	119
WAKAI HEAT CARRIERS .....	57
WALDSAVHS WIRE BENDING AND CUTTING PLIERS .....	134
WANGEN HOLDER .....	99
WARD FILLING INSTRUMENTS .....	80
WATER SYRINGE .....	116
WAX KNIVES .....	96
WAY 6 ADJUSTABLE ANGLED SCALPEL HANDLE .....	123
WEIDER RETRACTOR .....	99
WEINGART PLIER .....	139
WEINGART PLIER MEDIUM .....	132,134
WEINGART PLIERS .....	141
WEINGART UTILITY PLIERS .....	136
WEINGART-MINI UTILITY PLIERS .....	136
WEITLANER RETRACTORS - MOUTH GAGS .....	100
WERDELSTAEDT SCALER .....	67
WESTCOTT BURNISHERS .....	68
WESTCOTT FILLING INSTRUMENTS .....	93
WESTON CEMENT SPATULAS .....	95
WHITE BURNISHERS .....	68
WIDE SIOVELAND RETAINERS .....	115
WILAND SCALER .....	65
WILKINS/TUFTS EXPLORER .....	54
WILLIAMS EXPLORERS .....	55
WILLIAMS FILLING INSTRUMENTS .....	81
WINTER EXTRACTING FORCEPCS (AMERICAN PATTERN) .....	12
WINTER ROOTS ELEVATOR .....	41
WIRE BENDING & LOOP FORMING PLIERS .....	132
WIRE BENDING AND LOOP FORMING PLIERS ANGLED (BIRD BEAK) .....	136
WISDOM EXTRACTING FORCEPCS .....	03
WISDOM ROOT ELEVATOR .....	36
WITZEL FORCEPCS WITH ANATOMICAL HANDLE SET OF 3 PCS .....	09
WITZEL FORCEPCS WITH GOLD SET OF 3 PCS .....	09
WITZEL FORCEPCS WITH HOLE AND SCREW PATTERN SET OF 3 PCS .....	09
WITZEL ROOT FRAGMENT FORCEPCS .....	09
WOODEN HANDLE WAX KNIVES .....	96
<b>X</b>	
X RAY FILM HANGERS .....	94
<b>Y</b>	
YOUNG TONGUE FORCEPCS .....	110
YOUNG WIRE BENDING & LOOP FORMING PLIERS .....	132
YOUNGER GOOD SCALER .....	63
<b>Z</b>	
ZAHLE CEMENT SPATULAS .....	95



**Manufacturers & Exporters of Dental Instruments.**

📍 St. No. 5 Moh Darbar Shareef Pakka Garha Ghumman,  
Sialkot Pakistan

📞 +92 322 7490 679    📠 +92 329 6896 256

✉ info@shameelinstruments.com    sales@shameelinstruments.com

🌐 www.shameelinstruments.com

